



More than **sensors + automation**



Product Range

Sensor and automation solutions for your success

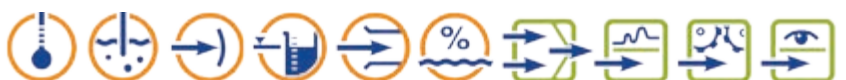



Dimitrios Charisiadis
Chief Executive Officer

Dipl.-Ing. Bernhard Juchheim
Chief Executive Officer and General Partner

Dipl.-Kfm. Michael Juchheim
Chief Executive Officer and General Partner

True quality leads to success

Since its founding in Fulda in 1948, JUMO has developed into a successful global player. Today, our company is represented on all 5 continents.

Anyone wishing to make a name for themselves in the competitive markets of the world with products and services must bring all their expertise to the table. The most important factors here are an innovative development department, products of superior quality, and reliable service. To achieve all of this, you must have one thing: highly motivated employees.











Today, our strong teams in all areas allow us to be placed among the leading manufacturers of industrial sensor and automation technology. We have over 2400 employees in 5 branch offices and 1 subsidiary in Germany as well as 24 subsidiaries and more than 50 agencies abroad.

The cornerstone of our corporate philosophy is the principle of holism. At JUMO we provide all-in-one solutions – from product development and production to Services & Support. This way, we have full control over all processes at all times and are able to make use of synergistic effects which benefit our customers.

The result is a product portfolio covering all aspects of measuring, controlling, and analyzing which is unparalleled in its scope and range. This brochure provides a clear introduction to this product spectrum. Please feel free to contact us for further information.



Contents

	Temperature	4
	Liquid analysis	6
	Pressure	10
	Level	12
	Flow	14
	Humidity	16
	Control	18
	Recording	20
	Automation	22
	Monitoring	26
	Engineering	30

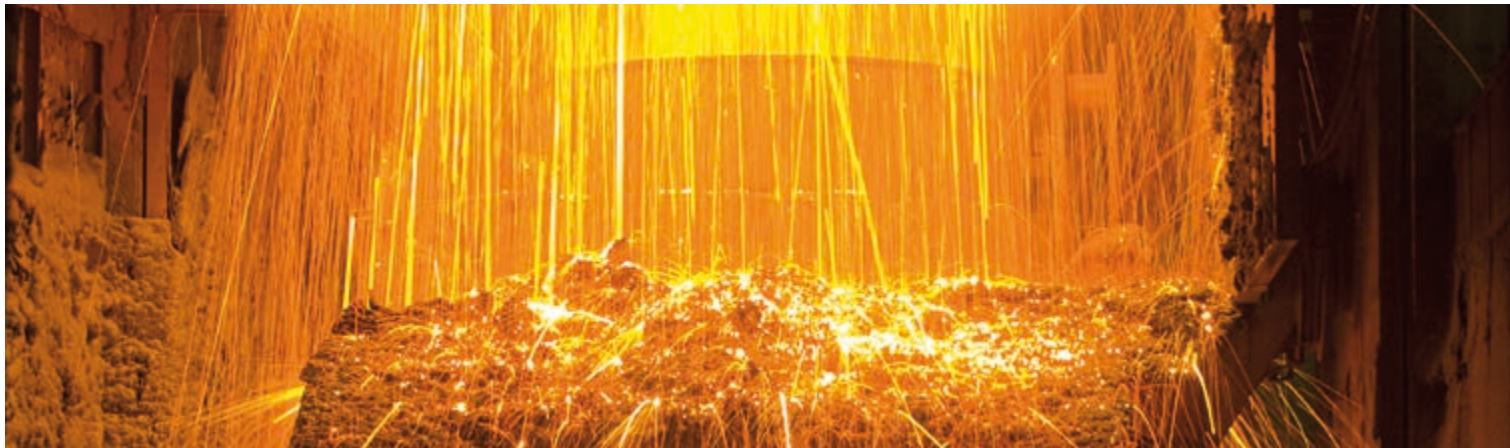

Temperature

Temperature is one of the most important measurands in a number of industrial areas. JUMO, your partner for precision temperature measurement, offers a wide range of products in this segment – from room temperature measurement in building technology to high-temperature measurements in furnace construction. The highest quality and reliability of our products is maintained by continuously developing them. We always focus on the customer in everything we do. Customer satisfaction and long-term collaboration are the driving forces that keep us achieving outstanding performance time and time again.

Portfolio:

- DAkkS calibration service
- Panel-mounted and surface-mounted thermostats
- Plastic temperature probes
- Temperature probes for
- Thermocouples
- Platinum-chip temperature sensors
- RTD temperature probes
- Dial thermometers



Approvals:



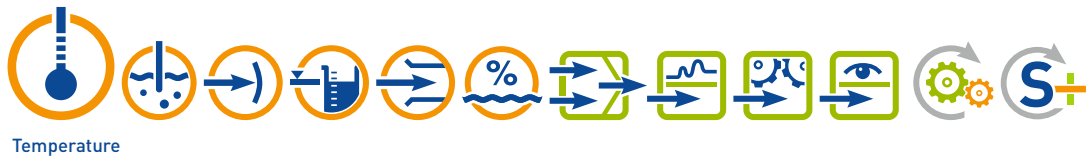

Temperature sensors for industry, plant engineering, and vehicle engineering

JUMO has been producing high-quality RTD temperature probes and thermocouples since the mid-1960s. Temperatures up to approximately 500 °C are generally measured using RTD temperature probes. The platinum temperature sensor has established itself by ensuring a high degree of measuring accuracy and long-term stability. Thermocouples are suitable for measuring higher temperatures. Here, thermocouples of type L, J, K, N, S, or B are used depending on the requirement. The in-house DAkkS lab and our own temperature sensor thin film production facilities enhance JUMO's expertise and offer our customers ultimate flexibility. JUMO is now one of the world's leading manufacturers in this field.

Electromechanical temperature monitoring

JUMO's decades of experience in manufacturing electromechanical thermostats and dial thermometers has made it a reliable partner. The ease with which our devices enable temperatures to be acquired and controlled without using auxiliary power has allowed these devices to become standard in various industry sectors. The array of products ranges from mass-produced products to individual customer solutions in small-scale production.

Thermocouples and RTD temperature probes with terminal head or connecting cable

Type 901020, 901030, 901120, 902020, 902023, 902030, 902120, 902123, 902820, 901150, 901190, 901210, 902050, 902150, 902153, 902190, 902210, 902350



RTD temperature probes with wireless data transmission

Type 902930, 902931, 707060



RTD temperature probes with plug connector

Type 902040, 902044



RTD temperature probes for industrial solutions

Type 902424, 902425, 902434, 902435, 902810, 902815, 902915, 902940



Indoor, outdoor, and channel RTD temperature probes

Type 902520



JUMO plastoSENS T01/02/03

Vibration-resistant, surge proof, and steam-tight plastic temperature probes
Type 904001, 904002, 904003



Platinum chip temperature sensors according to DIN EN 60751

Type 906121, 906122, 906123, 906124, 906125



Panel-mounted and surface-mounted thermostat

EM series, heatTHERM series
Type 602021, 603070



Dial thermometer

Type 608002





Liquid analysis

The JUMO range of analytical measurement products focuses on the most important chemical and electrochemical measurands in liquid media. This includes the pH value, redox potential, and ammonia as well as the electrolytic conductivity, dissolved oxygen, turbidity, free chlorine, total chlorine, chlorine dioxide, ozone, hydrogen peroxide, and peracetic acid. Sensors and measuring devices from JUMO are used in a variety of areas including drinking, service, and process water preparation. Today, JUMO is one of the leading manufacturers of measuring devices and sensors (including accessories) for electrochemical measurands.

Portfolio:

- Fittings
- Digital sensors
- Dissolved oxygen sensors
- Conductive and inductive conductivity sensors
- Transmitters and controllers
- pH and redox electrodes
- Sensors for chlorine, chlorine dioxide, bromine, ozone, hydrogen peroxide, and peracetic acid
- Turbidity sensors



Approvals:





JUMO digiLine

Intelligent, bus-compatible connection system for digital sensors used in liquid analysis

With JUMO digiLine, JUMO presents a bus-compatible connection system for digital sensors used in liquid analysis which also offers Plug and Play functionality. JUMO digiLine allows for the simple creation of sensor networks by connecting a wide array of sensors in various bus topologies (linear,

star). A single shared signal line is used for communication with the next evaluation unit or controller. This way plants in which several parameters need to be measured at the same time in different places can be wired efficiently and quickly.

Measure various liquid analysis measurands with just one system

- Measurands: pH value, temperature, redox potential, conductivity, oxygen concentration, turbidity, disinfection measurands
- For industrial applications in the process, food, pharmaceutical, and water industry
- Fail-safe digital data transfer for optimal process monitoring
- Modular system: for both individual measuring points and for setting up sensor networks
- Plug and Play function for connection to transmitters from the JUMO AQUIS touch series: facilitates the replacement of expended sensors or the brief exchange of sensors for calibration purposes
- The digiLine electronics can continue to be used even when the sensor becomes worn
- Simple and reliable calibration of sensors and comprehensive measuring point management can be completed easily on a PC with the JUMO DSM (Digital Sensor Management) software tool

Ready for measurement in just 3 steps – thanks to Plug and Play

1. Connect sensor

2. Sensor is detected automatically

3. Sensor is linked and ready for measurement

Bezeichnung	Parameter	
1 digitaler Sensor 1	pH	
2 digitaler Sensor 2	pH	
3	kein Sensor	
4	kein Sensor	
5	kein Sensor	
6	kein Sensor	

Sensor	HW-Adresse
pH	00001 A
pH	00001 B

Pressure

Pressure measurement is one of the most important tasks in almost all industrial sectors. High-quality pressure measuring devices ensure reliable and safe measuring results regardless of whether you are dealing with high-precision solutions for the process industry, hygienic solutions for the food and pharmaceutical sectors, or universal solutions for mechanical and plant engineering. JUMO also has the right solution for your specific application. We supply special solutions based on customer requirements for the OEM market.

Portfolio:

- Differential pressure transmitters
- Pressure transmitters
- Pressure transmitters for wireless data transmission
- Pressure measuring cells (analog and digital)
- Diaphragm seals and accessories
- Pressure switches
- Process pressure transmitters



Approvals:



250

Level

Our decades of experience with pressure measurement technology forms the basis for our developments in the field of hydrostatic level measurement. We offer solutions for pressurized and depressurized containers, wells, and waterbodies. You can record the level with level probes or pressure transmitters depending on the application.

Portfolio:

- Differential pressure transmitters (hydrostatic)
- Pressure measuring devices (hydrostatic)
- Level probes (hydrostatic)
- Floats (mechanical)
- Float switches and level transmitters



Approvals:



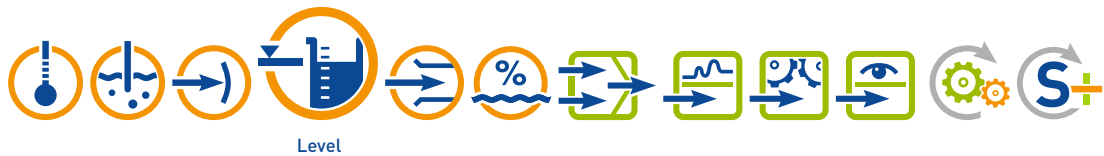

Hydrostatic level measurement: pressure as a means to an end

When taking level measurements, pressure measuring devices operate according to the hydrostatic principle. The hydrostatic pressure is created in a liquid by a liquid column located above a sensor and always behaves in proportion to the sensor's immersion depth.

The pressure measuring device is selected depending on the measuring task. Level probes and pressure measuring devices developed especially for determining the level are available for depressurized tanks or open bodies of water. The rack purification plant of a water works is one example of an application.

JUMO MIDAS DP10 or JUMO dTRANS p20 DELTA differential pressure measuring devices are the preferred solution for use on pressurized tanks. For hygienic reasons, the level can also be recorded from the outside using a relative pressure or differential pressure measuring device.

Float switches are used for point value measurement and level transmitters via floats are used for quasi-continuous level measurement of liquids. The measurement takes place according to Archimedes' principle and is suitable for unpressurized and pressurized tanks.

In addition to end devices, JUMO also offers mechanical floats for producing float switches.

JUMO MAERA series

Level probes

Type 401015, 402090, 404391, 404392, 404393



JUMO dTRANS p30 series

Pressure transmitters

Type 404366, 404753



JUMO DELOS SI and JUMO dTRANS p20

Pressure transmitters with a display for mounting on depressurized tanks

Type 405052, 403025, 403026



JUMO MIDAS DP10 and dTRANS p20 DELTA

Differential pressure transmitters for mounting on pressurized tanks

Type 401050, 403022, 403023



JUMO NESOS series

Float switches and level transmitters

Type 408301, 408302, 408303, 408320





Flow

JUMO offers you products with various features for flow measurement. In addition to differential pressure transmitters, JUMO's product range also includes paddle-wheel flow sensors and electromagnetic flowmeters. The result is that we have the right solution for all your applications, regardless of whether you're measuring the flow of gas, liquids, or slurry.

Portfolio:

- Differential pressure transmitters
- Flowmeters for vapors, gases, and liquids
- Paddlewheel flow sensors
- Electromagnetic flowmeters
- Flow sensors



Approvals:



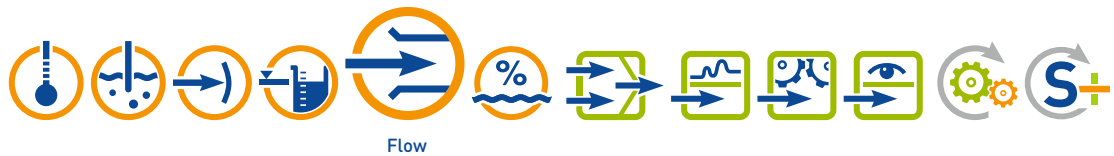

Precision flow measurement for

JUMO helps you safely design your process technology with sensors known for their long-term stability and precision. Depending on the application, we can provide the right flow sensors for liquids, gases, or vapors. If adjusted to the corresponding evaluation devices and controllers, the devices allow the flow to be measured, displayed, controlled, or recorded.

The JUMO product range comprises a wide range of devices. Orifice plates and Pitot probes offer the greatest device variety. When these are combined with differential pressure transmitters they also provide the best measuring accuracy.

We offer electromagnetic flowmeters especially for flow measurements in liquids. The devices were developed for industrial and hygienic applications. They are particularly flexible and available with a large variety of nominal widths, measuring tube linings, materials, and process connections.

JUMO flowTRANS MAG S01

Electromagnetic flowmeter for industrial applications
Type 406012



JUMO flowTRANS MAG H01

Electromagnetic flowmeter for hygienic applications
Type 406015



JUMO dTRANS p02/p20

Differential pressure transmitters
Type 404382, 403022, 403023



JUMO PINOS L02

Calorimetric flow sensor
Type 406041



JUMO flowTRANS MAG I02

MID flow transmitter
Type 406011



Fittings for flow sensors

Type 406090



Paddle wheel sensor

Type 406020



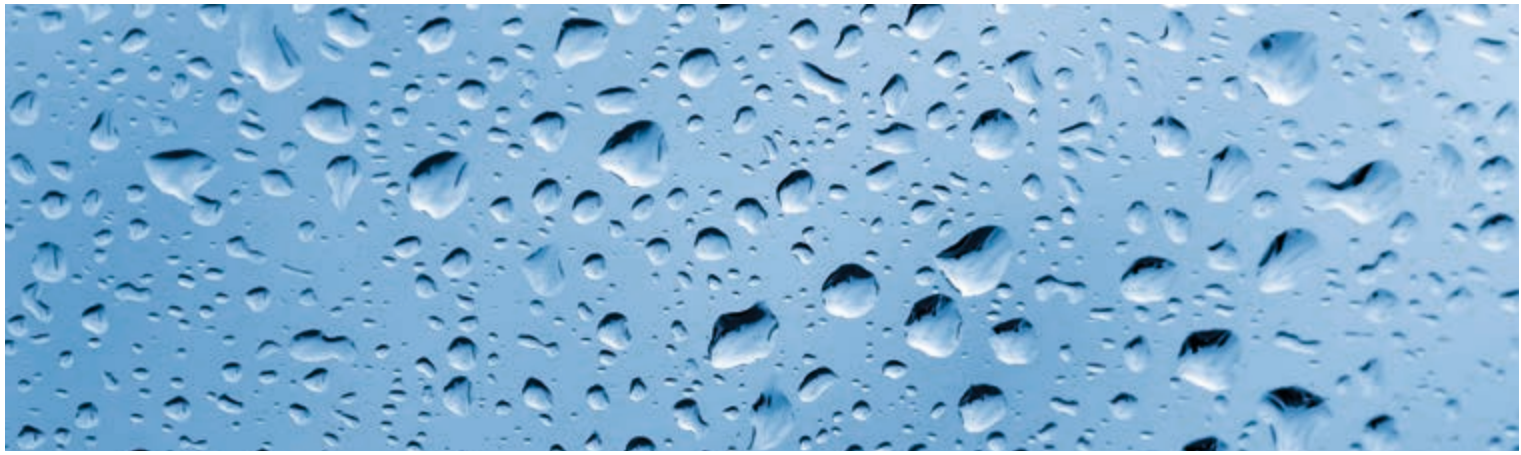

Humidity

For several decades, JUMO has been offering a very comprehensive and cutting-edge range of devices for measuring relative humidity and the measurands associated with air humidity. The devices are designed for most applications in air-conditioning and ventilation technology as well as for sophisticated industrial applications.

Portfolio:

- Intrinsically safe industrial measuring probes (ATEX)
- Hygrometric humidity measuring probes
- Hygrostats
- Capacitive humidity measuring probes
- Measuring probes for wireless data transmission



Approvals:



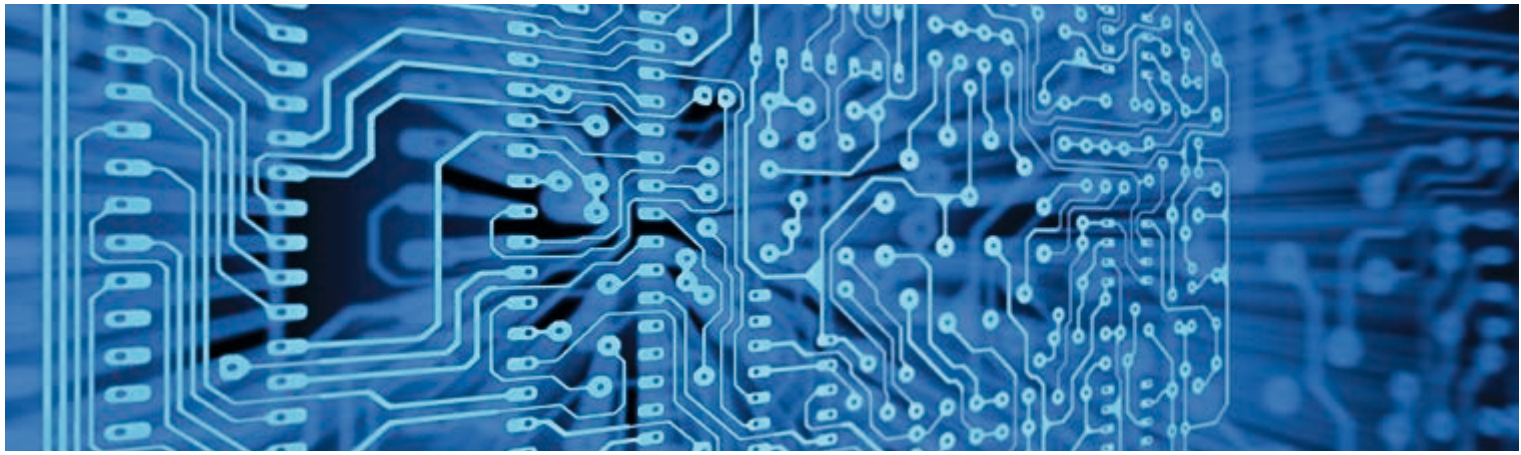

Control

However different the production processes in various industries may be, they all have in common that process variables such as temperature, pressure, humidity, flow, and level often need to be controlled with the highest levels of accuracy. You will be sure to find the right controller for your application in the JUMO product range, which spans from inexpensive electromechanical and electronic thermostats to digital compact controllers and multichannel automation systems.

Portfolio:

- Surface-mounted thermostats
- Panel-mounted thermostats
- Single channel and multichannel controllers
- Frost protection thermostats
- Process and program controllers
- Contact dial thermometers

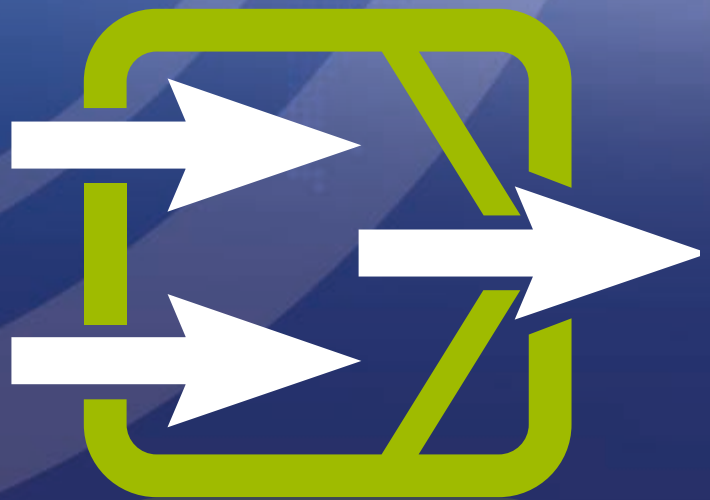

Approvals:



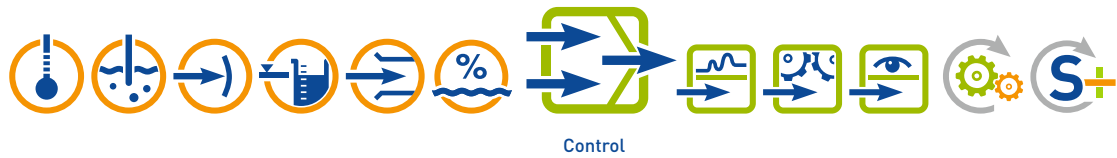

Programmable electronic controllers

Precision control of a wide range of measured values such as temperature, pressure, humidity, level, and many other measured values is crucial in today's industrial and process applications for consistently-high product quality. With our array of electronic controller products ranging from single channel controllers to multichannel screen controllers we provide the right solutions for your control requirements. The integrated self-optimization function ensures fast startup and cost savings at the same time. The universal measurement input enables the connection of a wide range of sensors while providing a high level of application flexibility. The optional interface technology allows for integration into the management and control systems and thereby reduces the load placed on the control technology.

Electromechanical thermostats

Electromechanical thermostats are used in both the heating and air-conditioning industry as well as in building automation. Temperatures in a variety of processes can be controlled without using auxiliary energy. Explosion-protected surface-mounted thermostats enable the maximum temperature control of electrical heating cables in industrial applications. Here, the thermostat stands out with its resistance to electromagnetic interference.

JUMO IMAGO 500

Multichannel process and program controller
Type 703590



JUMO DICON touch

Two-channel/four-channel process and program controller with paperless recorder and touchscreen
Type 703571



JUMO dTRON

Compact controller with program function
Type 703041



JUMO diraTRON

Compact controllers
Type 702110



JUMO heatTHERM

Surface-mounted and panel-mounted thermostat
Type 602031, 603070



JUMO exTHERM-AT

Explosion-protected surface-mounted thermostat
Type 605055

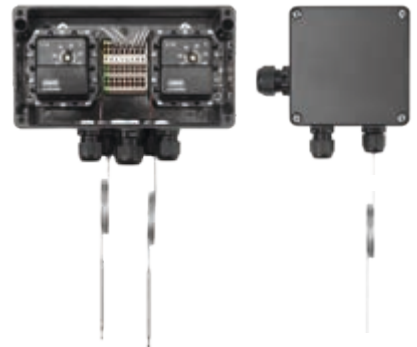

Panel-mounted thermostat

EM series
Type 602021



JUMO frostTHERM-AT/-DR/-ATE

Frost protection thermostats
Type 604100, 604170



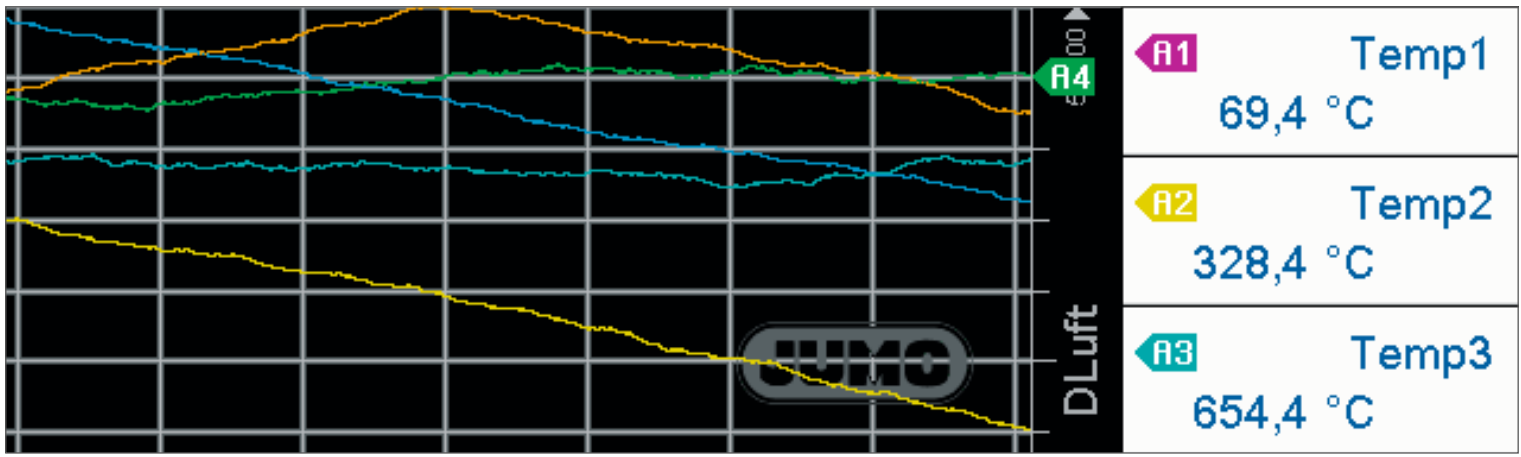

Recording

Are you familiar with the JUMO LOGOSCREEN type series? With the devices in this family of paperless recorders you are ideally equipped to acquire, archive, and evaluate measured values that must be verified in a tamper-proof manner. The devices can be used without restriction in almost all industries due to their flexibility and various approvals.

Portfolio:

- Paperless recorders
- Paperless recorder with AMS2750 and CQI-9 approval
- Paperless recorder with FDA approval
- Measuring, control, and automation system with extensive recording functions



Approvals:





Recording and visualization, evaluation and archiving

The recording and archiving of measurement data – especially when the obligation to provide evidence must be met – has long been part of JUMO's measurement technology and portfolio. Paperless recorders were designed as a high-quality replacement for paper recorders. They have developed significantly with plant visualization, monitoring functions, and web server connection.

JUMO LOGOSCREEN 601

In addition to its 5.7" touchscreen, the basic device of the series offers various digital interfaces, up to 6 universal inputs, the recording of a batch report, plant visualization, and limit value monitoring.

JUMO LOGOSCREEN 601

Paperless recorder with touchscreen
Type 706521



JUMO LOGOSCREEN 700

Highly scalable paperless recorder
Type 706530



JUMO LOGOSCREEN 700

The flagship of the series is highly scalable and can be equipped with up to 18 measurement inputs. It is also possible to generate 10 customer-specific process screens and up to 5 batch reports.

JUMO screen recorders meet the requirements of FDA 21 CFR Part 11 for the electronic recording of process data as the latest hash algorithms make the data tamper-proof.

JUMO mTRON T

The measuring, control, and automation system offers comprehensive recording functions. That enables the establishment of a decentralized system for acquiring and archiving a maximum of 54 analog measuring channels and 54 digital channels.

JUMO mTRON T – Multifunction panel 840

Measuring, control, and automation system
Type 705060

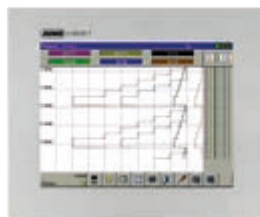

JUMO mTRON T – Central processing unit

Measuring, control, and automation system with controller module as well as input and output modules
Type 705001





Automation

To ensure smooth process and production operations you need reliable systems. From thyristor power controllers and temperature transmitters, to digital indicators, to our JUMO mTRON T and JUMO variTRON automation systems. JUMO meets all your automation and visualization demands.

Portfolio:

- Indicating devices
- Automation software
- Power controllers and solid state relays
- Transmitters
- Measuring, control, and automation system
- Transmitters for wireless data transmission
- Software and accessories
- System technology



Approvals:





Thyristor power controllers and solid state relays

In many electrically operated heating systems, solid state relays ensure wear-free switch operations with large currents and therefore play a key role in ensuring a high degree of heater availability. Using the JUMO TYA 200 series provides key advantages in thermal applications for which the precision dose of electrical heat output is vital for product quality and also for ensuring energy efficiency.

JUMO TYA 200 series

Single-phase and three-phase thyristor power controllers
Type 709061, 709062, 709063



JUMO TYA 432

Thyristor power switch
Type 709010, 709020

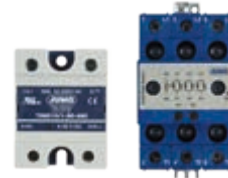

Temperature transmitter

The JUMO dTRANS T series offers the right transmitter for your specific application. Regardless of whether the transmitter is mounted in the probe head, in the line, or on a mounting rail, it converts the temperature measured by the connected sensor into a precise standard signal for further processing in your production plant. The JUMO dTRANS T09 cable transmitter is ideal for retrofitting or digitalizing existing plants. JUMO dTRANS T06 Ex is used, for example, in safety-relevant areas (SIL/PL) and Ex applications. In Ex applications, the Ex-i repeater power supply and input isolating amplifier also ensures safe isolation between the Ex and non-Ex areas.

JUMO dTRANS T05

Programmable two-wire transmitters
Type 707050, 707051

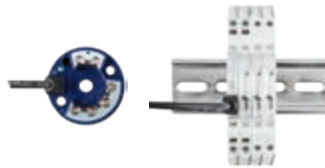

JUMO Ex-i repeater power supply and input isolating amplifier

Type 707530



JUMO dTRANS T06J, T06, T06 Ex

Multifunctional four-wire transmitter in mounting rail case
Type 707070, 707071, 707075



JUMO dTRANS T01 HART®/Ex

Programmable two-wire transmitters
Type 707013, 707016



Digital indicators

Digital indicators enable a precise on-site display of process values. They also allow you to keep an eye on values that are important for a smooth production process.

JUMO dTRANS T09

Cable transmitter for temperature
Type 707090



JUMO diraVIEW

Digital indicators
Type 701510



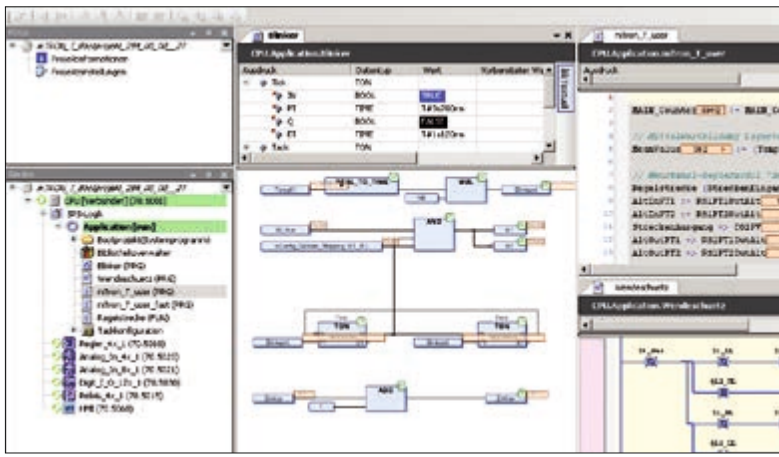

JUMO mTRON T

Measuring, control, and automation system – 705001

JUMO presented its mTRON decentralized automation system at the beginning of the new millennium. Today, JUMO mTRON T is used for a wide range of applications. After all, the modular system combines universal measured value recording with an intuitive, precise control system.



Features:

- Process mapping for up to 30 input and output modules
- 9 program generators
- 64 limit value monitoring functions
- Integrated web server
- PLC according to IEC 61131-3 (CODESYS V3.5)
- OPC server (OPC DA, in connection with PLC CODESYS V3.5)
- Tamper-proof data recording
- Math and logic module
- Meeting the requirements of the AMS2750 and CQI-9 specifications
- Plug and Play when replacing input and output modules
- Battery-buffered RAM
- Quick wiring of operating voltage and system bus provided by simple module connection principle



System structure – JUMO mTRON T

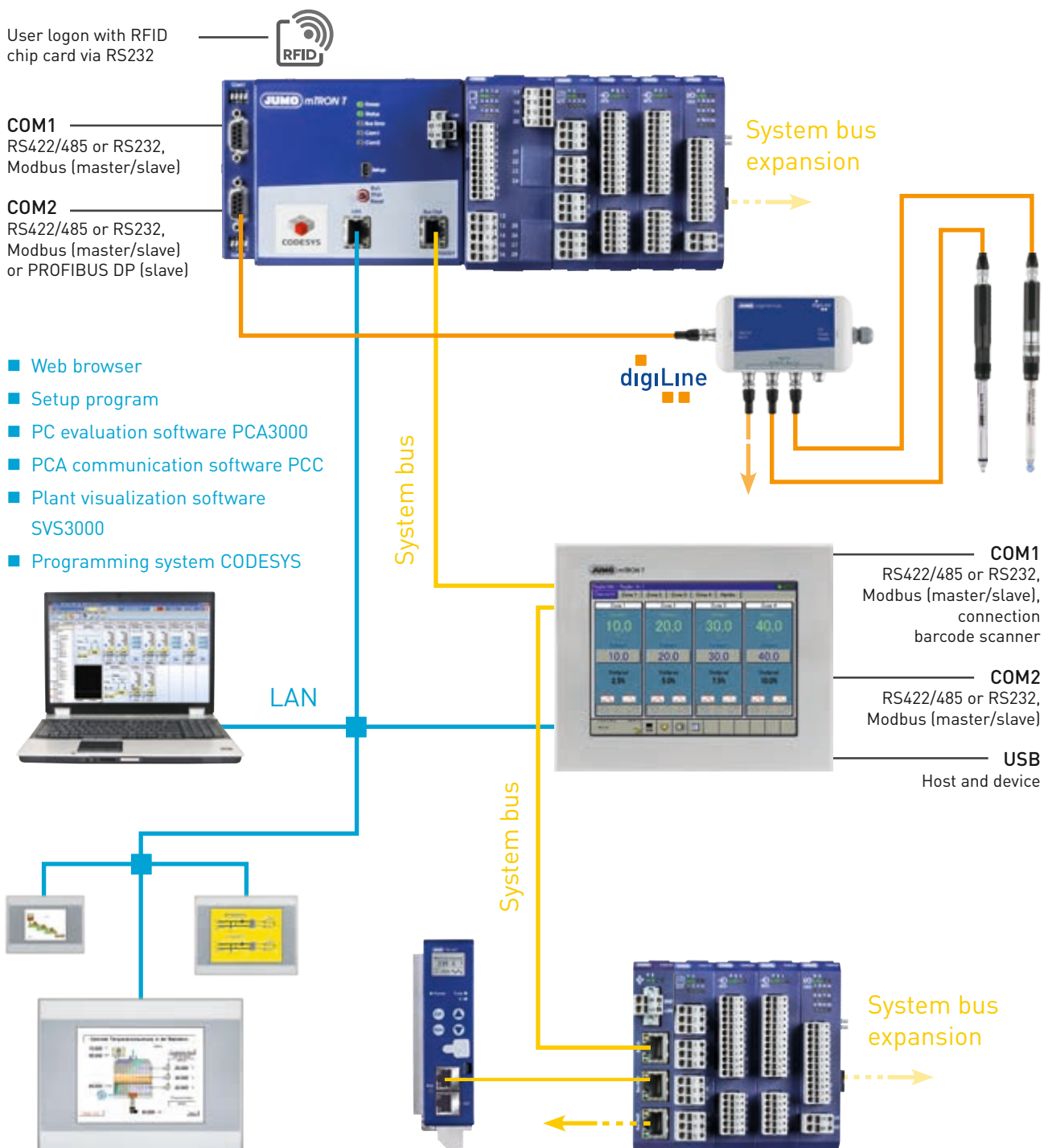



JUMO variTRON 500

Automation system – 705002

The new automation system from JUMO has a modular design and is highly scalable. JUMO variTRON 500 is based on the JUMO JUPITER hardware and software platform. CODESYS PLC transforms the system into a PLC, which can implement a wide range of control applications.



Features:

- High speed performance
- Flexible operating philosophy
- Simultaneous operation of more than 120 control loops
- Modern communication interfaces (e.g. OPC UA and MQTT)
- Integration of various fieldbus systems such as PROFINET, EtherCAT, and Modbus TCP/RTU
- Many degrees of freedom in software and hardware
- Easy integration of new software functions via CODESYS PLC
- Easy adaptation of hardware inputs and outputs
- Customer-specific operation and visualization of several operator stations via CODESYS Remote TargetVisu and CODESYS WebVisu
- More than 30 intelligent connection modules
- Panels in various formats (portrait or landscape, 4:3 or 16:9)
- Integrated JUMO web services

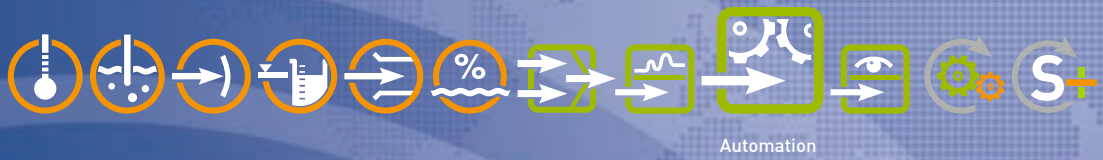

System structure – JUMO variTRON 500

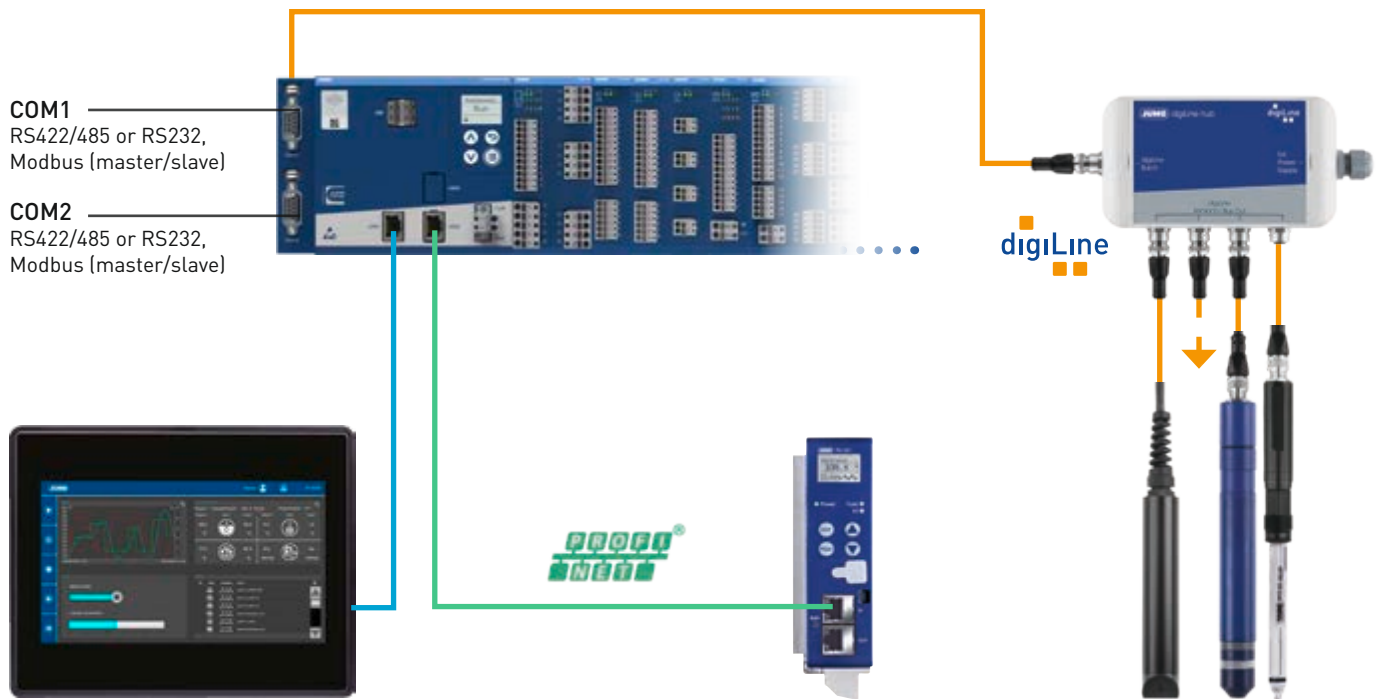



Monitoring

To protect people, the environment, the plant, and the product, monitoring temperature limit values is especially important in numerous technical areas of plants and even required by legal regulations in many cases. With JUMO you can operate your plant safely using either electronic or electromechanical products.

Portfolio:

- Surface-mounted thermostats
- Bimetal temperature switches
- Electronic thermostats
- Panel-mounted thermostats
- Safety temperature limiters and monitors according to DIN 14597
- Dial thermometers

Approvals:





Monitoring with electronic safety temperature limiters and monitors as well as electromechanical thermostats

Electronic temperature monitoring is vital in many applications. This is particularly so with safety-related temperature monitoring of special system equipment which can pose an enormous hazard to people, the environment, the product, and production system when defined limit values are breached. The safetyM product line allows JUMO to offer sophisticated electronic temperature limiters and monitors to avoid such hazards. The advantage of SIL-certified devices: in case the plant's defined maximum or minimum temperature is exceeded or not reached, the electronics ensure that the plant is switched off with the utmost precision.

In applications in which no auxiliary energy can be supplied to power the electronic components, the electromechanical thermostats reliably perform their tasks and thereby play a crucial role in ensuring a safe production plant or equipment design. The thermostats operate according to the liquid expansion principle: the liquids in the measuring system expand when heated and transmission mechanics activate a microswitch which then safely shuts down the system.

JUMO safetyM STB/STW Ex

Safety Temperature limiters and monitors according to DIN EN 14597 and ATEX approval
Type 701150, 701155



JUMO safetyM TB/TW 08

Temperature limiter and monitor according to DIN EN 14597 as built-in and DIN-rail device
Type 701160, 701170



Surface-mounted thermostat

ATH series
Type 603021



JUMO heatTHERM-AT

Surface-mounted thermostat
Type 603070



Panel-mounted thermostats

EM series, heatTHERM series
Type 602021, 602030, 602031

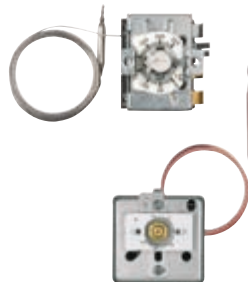

JUMO frostTHERM-AT/-ATE

Frost protection thermostats
Type 604100, 604170



Bimetal temperature switch

Type 608301



Dial thermometer

Type 608002





JUMO Safety Performance

The new brand for increased safety

JUMO Safety Performance is a new brand from JUMO. Products marked with this brand are suitable for safety-related plants. Included here are devices that are SIL and PL certified, but also passive elements that are suitable for use in SIL and PL measuring chains. These are labeled with "SIL qualified" and "PL qualified".



Functional safety – hassle-free!

Advantages of the new JSP (JUMO Safety Performance) brand

- Certified measuring chain protection up to SIL 3 and PL e possible
- Highest degree of flexibility for the configuration of the SIL components through comprehensive delivery program
- Safe monitoring and shutoff of systems
- Selectable security features (e.g. limiter or monitor function according to DIN 14597)
- Suitable for different measurands such as temperature, pressure, and level
- Variable, manufacturer-independent selection of sensor technology and actuators
- Certified measuring chain individually adaptable to the process requirement
- SIL calculation is no longer necessary by the user when the JUMO safetyM is used in combination with JUMO temperature probes
- Also available as explosion-protected compact solution according to ATEX directive in different ignition protection types such as [Ex i] and [Ex e]
- Individual assessment of the safety chain by the experienced JUMO Safety Performance team of experts



Safety-related switch-off up to SIL 3 (also in ATEX version)

Certified compact system for temperature

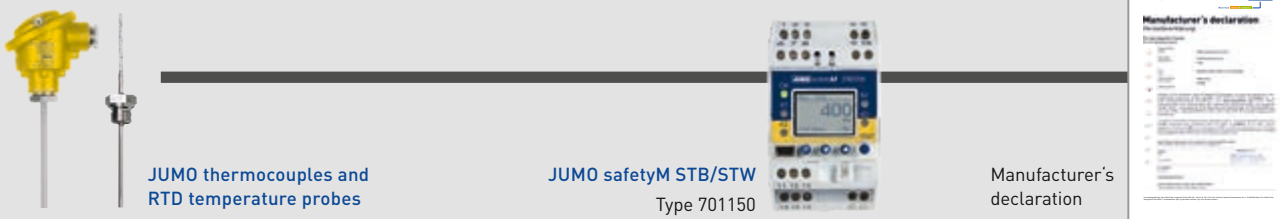

Compact system for temperature



Compact system for pressure



- The JUMO safetyM STB/STW has an output signal to control the downstreamed safety actuator systems.
- Additional output signal suitable for downstreamed visualization, controlling, and documentation.

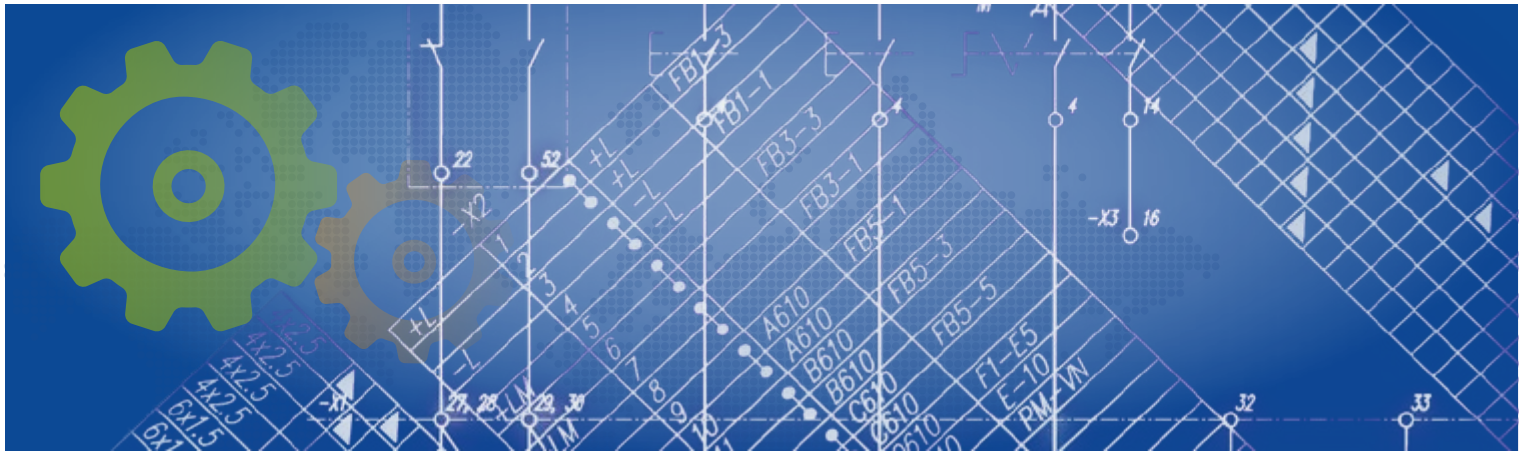

JUMO Engineering

JUMO Engineering, the service area from JUMO GmbH & Co. KG, combines expertise and industry-specific experience in one team. Our engineers and technicians develop customized solutions that are strictly based on your specific requirements. The JUMO Engineering team strongly believes in personalized support and consulting for its customers – from initial contact and the development of a customized solution to its series production. When carrying out the many different industry applications we always strive for optimum results with maximum customer benefits. Our innovative engineering services allow us to achieve this goal.



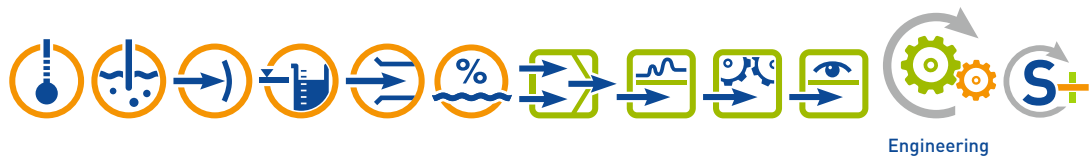

Innovative system solutions which specific expertise

We always draw on the feedback from our customers around the world to improve our products. This strategy is reflected in our new developments. We view complex tasks as challenges that allow us to develop tailored solutions for you and at the same time improve our product portfolio. JUMO Engineering with its range of services completes this comprehensive approach.

Our services

- Feasibility analysis
- Creating a technical concept including product requirements specifications and specification sheet
- Complete project planning and documentation
- Project planning including PLC programming, visualization, network technology, etc.
- Continuous project management
- On-site startup
- Training and support

Your advantages

- As a central contact partner JUMO develops technical system solutions
- Extensive expertise with all measurement and automation devices
- Global support through experienced specialists
- Flexible, tailored solutions to suit your individual needs and applications

In a nutshell

- Precise and prompt communication channels:
This saves you time and prevents mistakes!
- Highly developed expertise for maximum flexibility:
For fully reliable and secure project planning!
- Technology that has proven itself over decades reduces downtimes:
For excellent plant availability and process reliability!

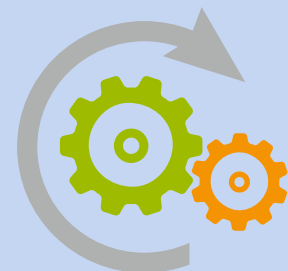



Services & Support

It is the quality of our products that is responsible for such a high level of customer satisfaction. But our reliable after-sales service and comprehensive support are also appreciated. Let us introduce you to the key services we provide for our innovative JUMO products. You can count on them – anytime, anywhere.

JUMO Services & Support – so that it all comes together!

Manufacturing Service

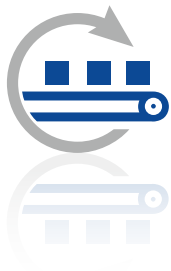

Are you looking for a competitive and efficient system or component supplier? Regardless of whether you seek electronic modules or perfectly fitting sensors, either for small batches or mass production – we are happy to be your partner. From development to production we can provide all the stages from a single source. In close cooperation with your business our experienced experts search for the optimum solution for your application and incorporate all engineering tasks. Then JUMO manufactures the product for you.

As a result, you profit from state-of-the-art manufacturing technologies and our uncompromising quality management systems.

Customer-specific sensor technology

- Development of temperature probes, pressure transmitters, conductivity sensors, or pH and redox electrodes according to your requirements
- A large number of testing facilities
- Incorporation of the qualifications into application
- Material management
- Mechanical testing
- Thermal test



Electronic modules

- Development
- Design
- Test concept
- Material management
- Production
- Logistics and distribution
- After-sales service



Metal technology

- Toolmaking
- Punching and forming technology
- Flexible sheet metal machining
- Production of floats
- Welding, jointing, and assembly technology
- Surface treatment technology
- Quality management for materials





Information & Training



Would you like to increase the process quality in your company or optimize a plant? Then use the offers available on the JUMO Web site and benefit from the know-how of a globally respected manufacturer. For example, under the menu item "Services and Support", you will find a broad range of seminars. Videos are available under the keyword "E-Learning" about topics specific to measurement and control technology. Under "Literature" you can learn valuable tips for beginners and professionals. And of course, you can also download the current version of any JUMO software or technical documentation for both newer and older products.

Product Service



We have an efficient distribution network on all 5 continents available to all of our customers so that we can offer professional support for everything concerning our product portfolio. Whether you need assistance in a consultation, with product selection, engineering, or optimum usage of our products – a team of professional JUMO employees is near you, ready to help. Even after our devices are commissioned you can count on us. Our telephone support line is available to give you answers quickly. If a malfunction needs to be repaired on site, our Express Repair Service and our 24-hour replacement part service are available to you. That provides peace of mind.

Maintenance & Calibration



Our maintenance service helps you to maintain optimum availability of your devices and plants. This prevents malfunctions and downtime. Together with the responsible parties at your company we develop a future-oriented maintenance concept and are happy to create all required reports, documentation, and protocols. Because we know how important precise measurement and control results are for your processes we naturally also professionally calibrate your JUMO devices – on site at your company or in our accredited DAkkS calibration laboratory for temperature. We record the results for you in a calibration certificate according to EN 10 204.



www.jumo.net

