

VACUUM EQUIPMENT FOR INDUSTRIAL APPLICATIONS

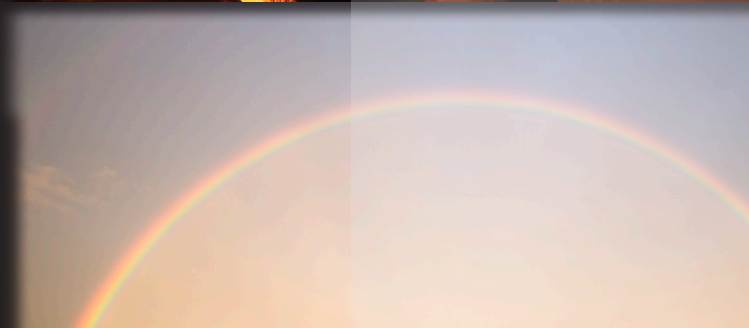

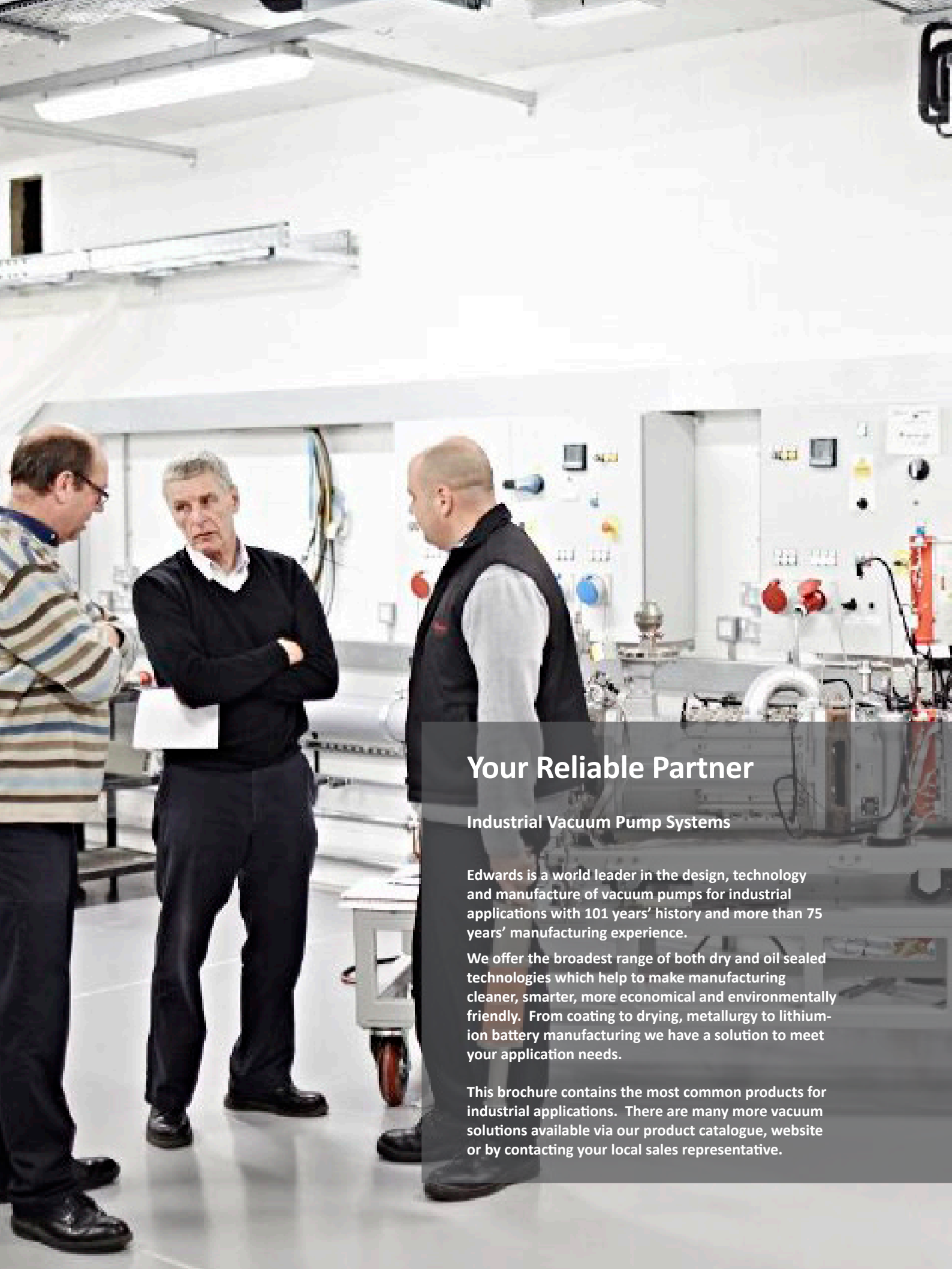

Your Reliable Partner

Industrial Vacuum Pump Systems

Edwards is a world leader in the design, technology and manufacture of vacuum pumps for industrial applications with 101 years' history and more than 75 years' manufacturing experience.

We offer the broadest range of both dry and oil sealed technologies which help to make manufacturing cleaner, smarter, more economical and environmentally friendly. From coating to drying, metallurgy to lithium-ion battery manufacturing we have a solution to meet your application needs.

This brochure contains the most common products for industrial applications. There are many more vacuum solutions available via our product catalogue, website or by contacting your local sales representative.

Vacuum products for key industrial applications

	Dry Pump	Single Stage Vane	Piston	Two Stage Vane	Dry Claw	Oil Sealed Screw
METALLURGY	Steel Degassing	•				
	Vacuum Induction Melting VIM	•		•		
	Vacuum Arc Refining VAR	•		•		
	Electroslag Remelting ESR	•		•		
	Precision Investment Casting PIC	•		•		
	Metal Injection Molding MIM	•		•		
	Sintering	•		•		
HEAT TREATMENT	Low Pressure Carburising LPC	•		•		
	Low Pressure Nitriding LPN	•		•		
	Plasma Nitriding PN	•		•		
	Nitro Carburising	•		•		
	Quenching	•	•	•	•	
	Tempering	•	•	•	•	
	Annealing	•	•	•	•	
	Vacuum Brazing VB	•	•	•	•	
	E-Beam Welding EBW	•		•	•	
	Plasma Welding	•		•		
COATING	Glass Coating	•	•	•	•	
	Plasma Spray	•	•	•	•	
	Surface Activation	•	•		•	
	Hard C CVD DLC	•	•		•	
	Plasma Deposition	•			•	
	Reflective & Decorative	•	•	•	•	
	Roll/Web Coating	•	•	•		
	Optical & Ophthalmic	•	•		•	
Display Coating	•	•		•		
DRYING	General Drying	•	•	•	•	•
	Packaging					•
	Li-ion Battery Drying	•	•			
	Capacitor Drying	•	•			
	Pipeline Drying	•		•		•
	Polymer Drying	•		•		
	Crystallization	•		•		
	Transformer Vapor Phase Drying	•		•		
	Bushing Filling	•		•		
	Transformer Drying	•	•	•		
	Freeze Drying	•		•	•	•
	Automotive Drying/Filling Systems	•	•		•	
	Refrigeration/AC Drying	•	•		•	
FOOD	Dairy				•	
	Meat Packaging				•	•
	Food Cooling				•	•
GENERAL INDUSTRIAL	Carbon Vapor Impregnation	•		•		
	Gas Recovery/Recycling	•			•	
	Space Simulation Chambers	•	•			•
	House Vacuum (not healthcare)	•	•			•
	Sterilisation	•	•			•
	Plasma Cleaning/Sterilising	•	•		•	
	Oil/Resin Degassing	•	•	•		
	Food Processing (not packaging)	•	•			•
	Plastics - extrusion, thermoforming & lamination	•				•
	Leak Detection	•	•	•	•	
	Cryo Interspace Evacuation	•	•	•	•	
	Vacuum Insulated Panels	•	•	•	•	
	Vacuum Insulated Glass	•	•	•	•	
	Vacuum Conveying					•
	Pick and Place					•
	Cylinder Filling	•	•		•	
	Secondary Pump Backing	•	•		•	

EDS DRY SCREW PUMP



Edwards' new range of EDS dry screw pumps feature an innovative design which creates a new benchmark in the screw pump market. An intricate piece of engineering, built to the exacting standards and quality demanded by our customers, the new dry screw pump provides you with a trouble-free and cost-effective solution to meet your needs.

Water-cooled, the EDS range is robust and efficient. Its second-to-none contaminant handling capability in the harshest industrial and chemical conditions make these pumps the smart choice for your industry. Cool and simple, easy to service and high speed, EDS vacuum pumps offer all the extra performance you need for the harshest and toughest industrial and chemical applications.

PRODUCT FEATURES

SIMPLE

Industry leading state-of-the-art screw vacuum technology simply packaged

FASTER

Extra performance to meet modern day technologies

FLEXIBLE

Designed for a changing global market

PROCESS CAPABLE

Mechanism proven in the most demanding applications

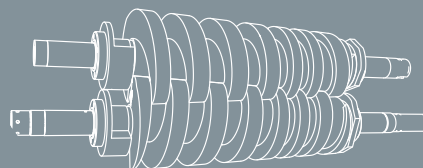

Technical Specifications

	Peak pumping speed		Ultimate pressure		Noise level	Full load power (@ ultimate pressure)	
	m ³ /hr ⁻¹	cfm	mbar	Torr	dB(A)	kW	Hp
EDS200 (water-cooled)	210	124	<0.05	<0.04	<76	4.1	5.5
EDS300 (water-cooled)	>280	>165	<0.01	<0.008	<76	4.5	6
EDS200 (air-cooled)	210	124	<0.05	<0.04	<76	4.1	5.5
EDS300 (air-cooled)	>280	>165	<0.01	<0.008	<76	4.5	6
EDS200 (chemical)	>280	124	<0.05	<0.04	<76	4.1	5.5
EDS300 (chemical)	>280	>165	<0.01	<0.008	<76	4.5	6

Dimensions

	Length		Width		Height		Inlet connection size	Outlet connection size
	mm	in	mm	in	mm	in	ANSI/DIN	ANSI/DIN
EDS (water-cooled)	1239	48.78	382	15.04	567	22.32	ISO63	NW40
EDS (air-cooled)	1623	63.90	499	19.65	567	22.32	ISO63	NW40
EDS (chemical)	1397	55	522	20.55	568	22.36	DIN80/3" ANSI	DIN50/2"ANSI

GXS DRY SCREW PUMP



Our GXS dry pumps provide high performance in tough applications. With unique screw technology and world leading high efficiency drives - enabling advanced temperature control and long service intervals - you are guaranteed best-in-class pumping speeds and low running costs for many years to come.

Be assured, the compact and highly intelligent GXS range of pumps and combinations are our most reliable and economical dry vacuum pumps for industrial applications.

Technical Specifications

	Peak pumping speed		Ultimate vacuum		Noise level dB(A)	Full load power			
	m ³ /hr	cfm	mbar	Torr		Ultimate pressure		Peak pumping load	
						kW	Hp	kW	Hp
GXS 160	160	94	7x10 ⁻³	5.3x10 ⁻³	<64	3.8	5.1	5	6.7
GXS 250	250	147	4x10 ⁻³	3x10 ⁻³	<64	4	5.4	9	12.1
GXS 160/1750	1200	706	7x10 ⁻⁴	5.3x10 ⁻⁴	<64	5.1	6.8	7.4	9.9
GXS 250/2600	1900	1118	5x10 ⁻⁴	3.8x10 ⁻⁴	<64	5.3	7.1	9.7	13
GXS 450	450	265	5x10 ⁻³	3.8x10 ⁻³	<64	7.2	9.6	17.3	22.3
GXS 750	740	436	3x10 ⁻³	2.3x10 ⁻³	<70	10	13.4	37	49.6
GXS 450/2600	2200	1295	5x10 ⁻⁴	3.8x10 ⁻⁴	<64	8.8	11.8	20	26.8
GXS 450/4200	3026	1781	5x10 ⁻⁴	3.8x10 ⁻⁴	<64	9.4	12.6	21.1	28.3
GXS 750/2600	2300	1354	5x10 ⁻⁴	3.8x10 ⁻⁴	<70	11.1	14.9	40	53.6
GXS 750/4200	3450	2031	5x10 ⁻⁴	3.8x10 ⁻⁴	<70	11.5	15.4	40	53.6

Dimensions

	Length		Width		Height		Inlet connection size	Outlet connection size
	mm	in	mm	in	mm	in	BSP	BSP
GXS 160	1092	42.99	390	15.35	568	22.36	ISO63	NW40
GXS 250	1092	42.99	390	15.35	568	22.36	ISO63	NW40
GXS 160/1750	1092	42.99	390	15.35	829.5	32.66	ISO63	NW40
GXS 250/2600	1092	42.99	390	15.35	829.5	32.66	ISO160	NW40
GXS 450	1186	46.69	517	20.35	717	28.23	ISO100	NW50
GXS 750	1622	63.86	517	20.35	717	28.23	ISO100	NW50
GXS 450/2600	1186	46.69	517	20.35	1030.5	40.57	ISO160	NW50
GXS 450/4200	1186	46.69	517	20.35	1030.5	40.57	ISO160	NW50
GXS 750/2600	1622	63.86	517	20.35	1030.5	40.57	ISO160	NW50
GXS 750/4200	1622	63.86	517	20.35	1030.5	40.57	ISO160	NW50

PRODUCT FEATURES

IMPROVED PRODUCTIVITY

Reduced pump down times with ultimate vacuum of 5x10⁻⁴ mbar for a faster process and better ultimate vacuum

ENHANCED RELIABILITY

Reliable operation even in harsh industrial applications, including oxygen-rich environments

INTELLIGENT CONTROL

On-board controller with extensive communication and automated control capabilities

ECONOMICAL

Low utilities and energy usage costs

REDUCED ENVIRONMENTAL IMPACT

Smooth, quiet running with low power and utilities consumption

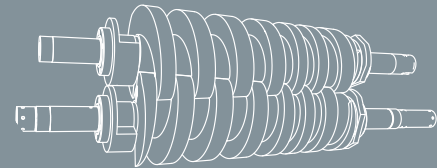

Drystar® GV80 PUMP



Drystar® GV80 is the most cost-effective solution using basic dry vacuum pumping technology. It is available as a stand-alone unit for 47 cfm (80m³h⁻¹) repeatable pumping performance; or in combination with the proven EH500 hydrokinetic drive mechanical booster, offering 295 cfm (500 m³h⁻¹) displacement for applications where increased pumping speed and/or lower vacuum levels are required.

PRODUCT FEATURES

VALUE FOR INVESTMENT

Low capital costs and minimised maintenance

RELIABLE

Suitable for harsh process conditions

EASY ON THE ENVIRONMENT

No contaminated or dirty oil to dispose of

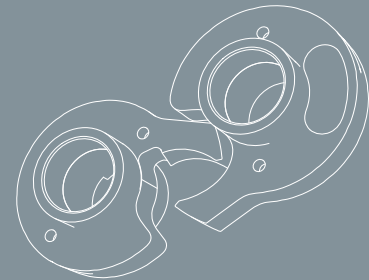

Technical Specifications

	Max pumping speed				Ultimate vacuum		Noise level dB(A)	Full load power			
	50 Hz		60 Hz		mbar	Torr		Ultimate pressure		Peak pumping load	
	m ³ /hr	cfm	m ³ /hr	cfm				kW	Hp	kW	Hp
GV80	80	47	94	56	<3x10 ⁻²	<2x10 ⁻²	<78	3.6	4.8	5.8	7.8
GV80/EH500	390	230	471	277	<3x10 ⁻³	<2x10 ⁻³	<78	4.3	5.6	6.7	9

Dimensions

	Length		Width		Height		Inlet connection size BSP	Outlet connection size BSP
	mm	in	mm	in	mm	in		
GV80	832	32.6	607	23.9	344	13.5	ISO40	ISO100
GV80/EH500	904	35.6	607	23.9	624	24.6	NW40	NW40

EDC DRY CLAW PUMP



Edwards' EDC range is a new generation of single stage dry claw vacuum pumps.

This range features an innovative design which creates a new benchmark in the claw pump market. The simplicity, efficiency and contaminant-handling capability of these pumps make them the smart choice for your application.

Built to the exacting standards and quality demanded by our customers, the EDC provides you with a trouble-free and cost-effective solution to meet your needs.

PRODUCT FEATURES

BUILT TO LAST

Innovative construction materials and coatings for a lifetime of reliable operation even in harsh conditions

EASY MAINTENANCE

Simplest of designs suited for quick access to the pumping chamber for easy cleaning in the event of product carry-over

LOW MAINTENANCE COST

Long-life bearings and seals with a separate and isolated pumping element

IMPROVED PRODUCTIVITY

Unrivalled performance: best-in-class ultimate vacuum level, market leading pumping speed and lower continuous vacuum level



Technical Specifications

	Nominal displacement		Ultimate vacuum			Noise level	Permissible ambient temperature range		Nominal motor rating	
	m ³ /h	cfm	mbar(a)	Torr	Hg Vac	dB(A)	°C	°F	kW	Hp
EDC 065 50 Hz	65	38	50	37.5	28.4	66	-10 to 40	14 to 105	1.8	2.4
EDC 065 60 Hz	78	46	50	37.5	28.4	70	-10 to 40	14 to 105	2.2	2.9
EDC 150 50 Hz	150	88	50	37.5	28.4	73	-10 to 40	14 to 105	3.7	5
EDC 150 60 Hz	180	106	50	37.5	28.4	79	-10 to 40	14 to 105	4.4	6
EDC 300 50 Hz	300	176	140	105	25.8	77	-10 to 40	14 to 105	6.2	8.3
EDC 300 60 Hz	360	212	140	105	25.8	82	-10 to 40	14 to 105	7.4	10

Dimensions

	Length		Width		Height		Inlet connection size	Outlet connection size
	mm	in	mm	in	mm	in	BSP	BSP
EDC 065	920	36.2	394	15.5	545	21.4	G 1 1/4"	G 1 1/4"
EDC 150	934	36.7	394	15.5	545	21.4	G 1 1/4"	G 1 1/4"
EDC 300	1110	43.7	500	19.6	688	27	G 2"	G 1 1/4"

IDX DRY SCREW PUMP

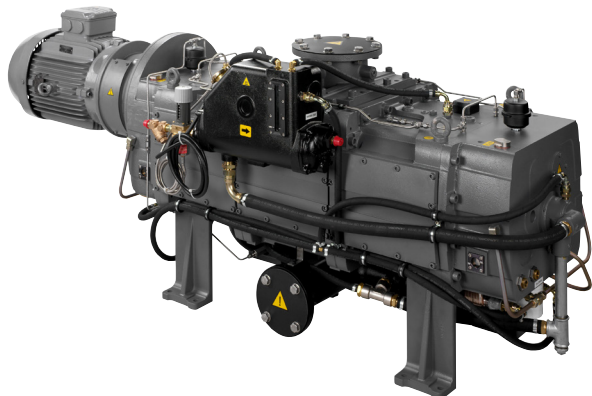

The IDX is the benchmark in performance for fast pumpdown of large chambers and high capacity pumping for industrial processes. Based on double-ended screw technology, the IDX dry vacuum pump will give you all the reliability and performance you want for your process. These pumps offer the ability to handle large volumes of dust and water vapor without any loss of performance while minimising maintenance requirements and running costs.

IDX pumps are available to be configured with a variety of vacuum booster pumps. Information on boosters can be found in this brochure - speak with Edwards about system configurations.

PRODUCT FEATURES

CONSISTENT OPERATION

Continuous performance from atmosphere to ultimate

PROTECTS YOUR PROCESS

Does not contaminate your process

REDUCED ENERGY COSTS

Excellent thermal profile and temperature control

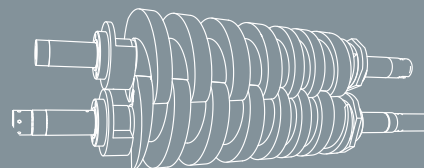

Technical Specifications

	Pumping speed (actual)		Ultimate pressure		Noise level	Motor rating	
	m ³ /hr ⁻¹	cfm	mbar	Torr	dB(A)	kW	Hp
IDX1000	900	560	5x10 ⁻²	3.75x10 ⁻²	<82	30	40
IDX1300	1250	736	5x10 ⁻²	3.75x10 ⁻²	<82	30	40

Dimensions

	Length		Width		Height		Inlet connection size	Outlet connection size
	mm	in	mm	in	mm	in		
IDX1000	2290	90.1	750	29.5	854	33.6	6"/DN150	3"/DN80
IDX1300	2515	99	750	29.5	1005	39.6	6"/DN150	3"/DN80

EOSi OIL SEALED ROTARY SCREW PUMP



Edwards EOSi range is a new generation range of quiet, oil sealed rotary screw vacuum pumps.

With Variable Speed Drive (VSD) technology and intelligent control, the EOSi range delivers impressive on-demand performance capability and optimises energy consumption.

The highly efficient patented oil separator design extends service intervals and reduces maintenance costs. Temperature management control enables unrivaled water handling capability to provide you with the versatility and flexibility you need for your application.

PRODUCT FEATURES

INCREASED EFFICIENCY

State-of-the-art screw technology, Variable-Speed, innovative motor design

IMPROVED PRODUCTIVITY

Class-leading pumping speed and fast chamber pumpdown capability

INTELLIGENT CONTROL

Closed loop pressure control and active power management

LOW COST OF OWNERSHIP

Automatic pumping performance matched to vacuum demand

REDUCED ENVIRONMENTAL IMPACT

Excellent oil retention at all operating pressures

Technical Specifications

	Peak pumping speed		Ultimate vacuum		Noise level range	Shaft power	Permissible ambient temperature	
	m ³ /hr	cfm	mbar	Torr	dB(A)	kW	C	F
EOS 350i	400	240	0.35	0.26	51-65	5.5	0-46	32-114.8
EOS 585i	560	330	0.35	0.26	51-65	7.5	0-46	32-114.8
EOS 730i	730	430	0.35	0.26	51.73	11	0-46	32-114.8
EOS 900i	900	530	0.35	0.26	51.76	15	0-46	32-114.8
EOS 1300i	1250	740	0.35	0.26	65-75	22	0-46	32-114.8
EOS 1600i	1590	940	0.35	0.26	65-79	30	0-46	32-114.8
EOS 1900i	1810	1070	0.35	0.26	65-80	37	0.46	32-114.8
EOS 3800i	3828	2253	0.3	0.23	78*	55	0-46	32-114.8
EOS 4600i	4478	2636	0.3	0.23	80*	75	0-46	32-114.8
EOS 5400i	5004	2945	0.3	0.23	82*	90	0.46	32-114.8

* Indicates maximum noise level

Dimensions

	Length		Width		Height		Inlet connection size	Outlet connection size
	mm	in	mm	in	mm	in		
EOS 350i	1266	49.84	934	36.77	1083	42.64	DN80	DN60
EOS 585i	1266	49.84	934	36.77	1083	42.64	DN80	DN60
EOS 730i	1266	49.84	934	36.77	1083	42.64	DN80	DN60
EOS 900i	1266	49.84	934	36.77	1083	42.64	DN80	DN60
EOS 1300i	1420	55.90	1590	62.60	1470	57.87	DN150	DN100
EOS 1600i	1420	55.90	1590	62.60	1470	57.87	DN150	DN100
EOS 1900i	1420	55.90	1590	62.60	1470	57.87	DN150	DN100
EOS 3800i	2850	112.20	1939	76.33858	1893	74.52756	DN200	DN150
EOS 4600i	2850	112.20	1939	76.33858	1893	74.52756	DN200	DN150
EOS 5400i	2850	112.20	1939	76.33858	1893	74.52756	DN200	DN150

STOKES MICROVAC ROTARY PISTON PUMP



For maximum performance and reliability, Stokes Microvac sets the standard as the industry's most efficient rotary piston pump, with minimal maintenance and process downtime.

Now improved, upgraded and fine-tuned, the new 'J' series delivers optimal performance and low operating costs.

Stokes pumps are available to be configured with a variety of vacuum booster pumps. Information on boosters can be found in this brochure - speak with Edwards about system configurations.

PRODUCT FEATURES

VALUE FOR INVESTMENT

Low rotational speed enables longest pump life cycle

EASY MAINTENANCE ON SITE

Rugged, simple mechanism for high reliability and ease of rebuild

COMPACT

Space-saving design: up to 50% of valuable floor space

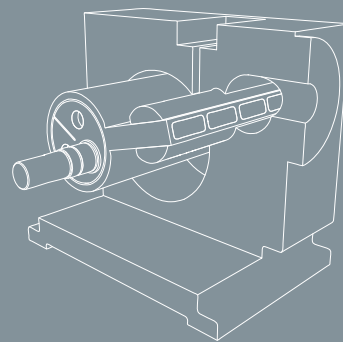

Technical Specifications

	Max Pumping Speed		Ultimate vacuum		Noise level dB(A)	Motor power			
	50 Hz	60 Hz				50 Hz		60 Hz	
	m ³ /hr	cfm	mbar	Torr		kW (TEFC)	Hp - IEC (CE)	kW	Hp
212J	234	138	<3.3x10 ⁻²	<2.5x10 ⁻²	<77	5.5	7.5	5.5	7.5
412J	442	260	<3.3x10 ⁻²	<2.5x10 ⁻²	<85	11	15	7.7	10*
612J	884	520	<3.3x10 ⁻²	<2.5x10 ⁻²	<85	11	15	7.7	10

* Optional 15Hp motor for 412J version

Dimensions

	Length		Width		Height		Inlet connection size	Outlet connection size
	mm	in	mm	in	mm	in		
212J	667	26.25	610	24	1105	43.5	3" ASA/ANSI flange	2" ASA/ANSI or 3" NPT
412J	1022	40.25	661	25.625	1314	51.75	4" ASA/ANSI flange	3" ASA/ANSI or 3" NPT
612J	1137	43.75	1178	70	1438	56.625	6" ASA/ANSI flange	3" ASA/ANSI or 3" NPT

nES SINGLE STAGE ROTARY VANE PUMP



The Edwards nES single stage series represents the next advancement in oil sealed rotary vane vacuum pumps for use in a wide range of industries and applications.

Offering high reliability, low life cycle cost and proven performance, the nES series provides an ideal solution to suit a broad range of requirements.

PRODUCT FEATURES

PROVEN PERFORMANCE

Consistent pumping performance with excellent vacuum stability

HIGH RELIABILITY

Engineered with high quality components, an effective oil return system and integrated mist filter, the nES series is designed to maximise process efficiency

COMPACT AND CLEAN

Compact in design with low noise and vibration which minimises environmental impact

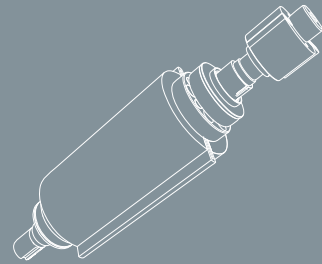

Technical Specifications

	Maximum Pumping Speed				Ultimate vacuum		Noise level		Motor power			
	50 Hz		60 Hz		mbar	Torr	dB(A)		50 Hz		60 Hz	
	m ³ /hr	cfm	m ³ /hr	cfm			50 Hz	60 Hz	kW	Hp	kW	Hp
nES40	38.5	22.7	47	27.7	0.5	0.4	58	60	1.5	2.0	1.8	3.0
nES65	54	31.8	64	37.7	0.5	0.4	60	64	2.2	3.0	2.6	4.0
nES100	87.5	51.5	105	61.8	0.5	0.4	61	64	3.0	5.0	3.6	6.0
nES200	170	100	200	118	0.08	0.06	69	73	5.5	8.0	6.6	10
nES300	240	141	290	171	0.08	0.06	72	76	7.5	10	9	13
nES470	400	236	470	277	0.08	0.06	72	75	11	15	13.2	18
nES570	470	277			0.08	0.06	75		11	15		
nES630	640	377	755	444	0.08	0.06	72	75	18.5	26	21	30
nES750	755	444			0.08	0.06	75		18.5	26		

Dimensions

	Length		Width		Height		Inlet connection size	Outlet connection size
	mm	in	mm	in	mm	in		
nES40	623	24.53	332	13.07	296	11.65	ISO40/G1 ¼	ISO40/G1 ¼
nES65	706	27.80	367	14.80	312	12.28	ISO40/G1 ¼	ISO40/G1 ¼
nES100	762	30.00	434	17.08	317	12.48	ISO40/G1 ¼	ISO40/G1 ¼
nES200	1100	43.31	535	21.06	415	16.34	ISO63/G2	ISO63/G2
nES300	1143	45.00	573	22.56	450	17.72	ISO63/G2	ISO63/G2
nES470	1305	51.38	863	33.98	733	28.86	ISO100/G3	ISO100/G3
nES570	1305	51.38	863	33.98	733	28.86	ISO100/G3	ISO100/G3
nES630	1566	61.65	989	38.94	740	29.13	ISO100	ISO100
nES750	1566	61.65	989	38.94	740	29.13	ISO100	ISO100

EM SERIES ROTARY VANE PUMP



EM series pumps are rugged mechanical oil sealed pumps with capacity ranging from 30 to 206 CFM (40 to 275 m³/hr). Compact and quiet, they feature advanced lubrication circuits, high reliability and accessories to suit specific application needs.

EM pumps are available to be configured with a variety of vacuum booster pumps. Information on boosters can be found in this brochure - speak with Edwards about system configurations.

PRODUCT FEATURES

RELIABLE AND STABLE PROCESS

Effective lubrication even under high gas loads

PROTECTION FROM CONTAMINATION OF PROCESS

Oil and air suck-back

PEACE OF MIND

Tried, tested - the industry standard for years

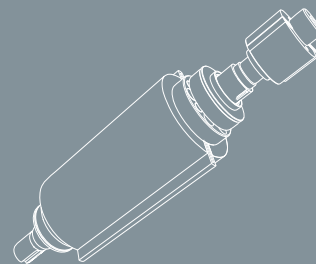

Technical Specifications

	Maximum Pumping Speed				Ultimate vacuum		Noise level dB(A)	Motor power			
	50 Hz		60 Hz		mbar	Torr		50 Hz		60 Hz	
	m ³ /hr	cfm	m ³ /hr	cfm					50 Hz	Hp	kW
E2M40	37	21.8	44	25.9	1x10 ⁻³	7.7x10 ⁻⁴	65	1.1	1.5	1.5	2
E2M80	74	43.6	90	53	1x10 ⁻³	7.7x10 ⁻⁴	70	2.2	3	3	4
E2M175	160	94	196	115	1x10 ⁻³	7.7x10 ⁻⁴	75	5.5	7.5	6.5	8.5
E2M275	255	150	306	180	1x10 ⁻³	7.7x10 ⁻⁴	75	7.5	10	8.5	11

Dimensions

	Length		Width		Height		Inlet connection size	Outlet connection size
	mm	in	mm	in	mm	in		
E2M40	690	27.12	240	9.45	395	15.55	ISO40	25mm flange (suitable for NW25)
E2M80	815	32.09	266	10.47	429	16.89	ISO40	25mm flange (suitable for NW25)
E2M175	1140	44.88	388	15.28	519.5	20.45	ISO63 blank flange with seal	ISO40 flange center tapped
E2M275	1185	46.65	388	15.28	519.5	20.45	ISO63 blank flange with seal	ISO40 flange center tapped



Vacuum Pumps for Chemical Applications

Many chemical processing and manufacturing applications require vacuum, for a wide variety of purposes and benefits. Vacuum systems need to handle organic solvents and compounds in a reliable and safe way while ensuring control and reduction of environmental pollution and cost of ownership.

Edwards has developed comprehensive dry solutions for vacuum pumping applications in the Chemical Process Industries to address these challenges.

Vacuum products for key chemical applications

	Chemical Dry Pump	Mechanical Booster	Rotary Piston Pump	Rotary Vane Pump	Liquid Ring Pump	Steam Ejector
Distillation, normal	✓ ✓	✓ ✓	✓	✓	✓ ✓	✓ ✓
Short path distillation	✓ ✓	✓ ✓	✓	✓		✓ ✓
Molecular distillation	✓ ✓	✓ ✓	✓	✓	✓	✓ ✓
Reactor service	✓ ✓	✓ ✓	✓		✓ ✓	✓
Central vacuum (flammables and corrosives)	✓ ✓	✓ ✓			✓ ✓	
Biofuels	✓ ✓	✓ ✓			✓ ✓	✓ ✓
Drying, evaporation, crystallisation, concentration	✓ ✓	✓ ✓	✓	✓	✓	✓
Gas recovery / recirculation	✓ ✓	✓ ✓				
Degassing	✓ ✓	✓ ✓	✓	✓ ✓	✓ ✓	✓
Absorption, adsorption, desorption	✓ ✓	✓ ✓			✓ ✓	
Pervaporation	✓ ✓	✓ ✓			✓ ✓	
Solvent recovery	✓ ✓	✓ ✓			✓	
Isocyanates production	✓ ✓	✓ ✓		✓	✓ ✓	✓ ✓
Impregnation	✓ ✓	✓ ✓	✓ ✓	✓ ✓	✓ ✓	
Polymers and plastics production	✓ ✓	✓ ✓	✓	✓	✓ ✓	✓ ✓
Paint, pigments, coatings and ink production	✓ ✓	✓ ✓	✓	✓ ✓	✓	✓
Soaps / detergents production	✓ ✓	✓ ✓	✓			✓ ✓
Ethylene Oxide sterilisation	✓ ✓	✓ ✓		✓ ✓		
Oil treatment plants	✓ ✓	✓ ✓	✓ ✓	✓	✓	✓
Dewatering and filtration	✓ ✓	✓ ✓			✓ ✓	
Flammable and corrosive gases	✓ ✓	✓ ✓		✓	✓ ✓	✓ ✓

	Lowest cost of ownership		High cost of ownership typically		Highest cost of ownership typically
--	--------------------------	--	----------------------------------	--	-------------------------------------

EDP CHEMICAL DRY PUMP



The Edwards EDP dry chemical pump is based on Edwards' oil-free, non-contacting, award-winning, reverse claw mechanism. It provides consistent vacuum at high efficiencies, low cost of ownership and is designed to meet the highest safety and performance standards.

We offer a range of four pumps with 47-235 cfm (80-400 m³h⁻¹) capacity, and ultimate vacuums of less than 1 Torr.

EDP pumps are available to be configured with a variety of vacuum booster pumps. Information on boosters can be found in this brochure - speak with Edwards about system configurations.

PRODUCT FEATURES

INDUSTRY PROVEN, TRIED AND TESTED

Specifically designed for chemical applications

DESIGNED AND TESTED FOR SAFETY AND RELIABILITY

Stable operation, even during process upsets

LOW COST OF OWNERSHIP

Easy maintenance, low utilities consumption and no cooling gas injection required



Technical Specifications

	Max Pumping Speed				Ultimate vacuum				Noise level		Nominal motor rating			
	50 Hz		60 Hz		50 Hz		60 Hz		dB(A)		50 Hz		60 Hz	
	m ³ /hr	cfm	m ³ /hr	cfm	mbar	Torr	mbar	Torr	50 Hz	60 Hz	kW	Hp	kW	Hp
EDP 80	83	49	102	60	0.5	0.4	0.3	0.2	73	73	5.5	7.5	5.5	7.5
EDP 160	163	96	202	119	0.5	0.4	0.3	0.2	77	78	7.5	10	11	15
EDP 250	260	153	320	188	0.5	0.4	0.2	0.2	79	79	11	15	15	20
EDP 400	377	222	427	251	0.4	0.3	0.2	0.2	82	82	18	25	25	30

Dimensions

	Length		Width		Height		Inlet connection size	Outlet connection size
	mm	in	mm	in	mm	in	ANSI/DIN	ANSI/DIN
EDP 80	700	27.6	850	33.5	1423	56	2"/DN50	1.5"/DN40
EDP 160	700	27.6	850	33.5	1458	57.4	3"/DN80	1.5"/DN40
EDP 250	1000	39.4	950	37.4	1681	66.2	3"/DN80	2"/DN50
EDP 400	997	37.2	946	37.2	1721	67.8	3"/DN80	2"/DN50

CXS CHEMICAL DRY PUMP



Edwards is synonymous with vacuum. Having hundreds of thousands of dry pumps installed worldwide, our high quality products and application know-how are renowned in the world of vacuum technology.

Featuring advanced tapered-screw technology for exceptional performance and energy efficiency, CXS vacuum pumps and combinations are at the cutting edge of chemical pump design.

The CXS is explosion tested and certified by independent authorities to meet strict safety standards. It is suitable for Hazardous Locations Class 1, Groups C&D, Division 1 Environments.

PRODUCT FEATURES

REDUCED INSTALLATION COSTS
Easy integration with other systems

INCREASED PRODUCTIVITY
Long intervals between services and no unplanned downtime

ENVIRONMENTALLY FRIENDLY
No oil, quiet operation

ECONOMICAL
Affordable capital investment and low cost of ownership

RELIABLE
Cutting edge screw technology for corrosion-free operation and excellent liquid and solids handling

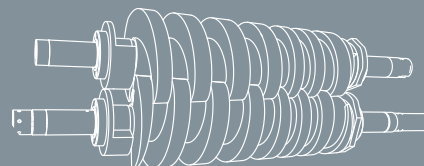

Technical Specifications

	Peak pumping speed		Ultimate vacuum		Noise level	Power consumption at 10 mbar (7.5 Torr)	
	m ³ /hr	cfm	mbar	Torr	dB(A)	kW	Hp
CXS160	160	95	<.02	<.015	64	3.6	4.8
CXS 250	250	148	<.015	<.011	64	3.8	5.1
CXS 160/EH500	499	294	<1.3x10 ⁻³	<1x10 ⁻³	<70	6.8	9.1
CXS 160/EH1200	1049	618	<1.3x10 ⁻³	<1x10 ⁻³	<70	7.7	10.3
CXS 250/EH1200	1145	674	<1.3x10 ⁻³	<1x10 ⁻³	<70	8.3	11.1
CXS 250/EH2600	2269	1336	<1.3x10 ⁻³	<1x10 ⁻³	<70	16	21.4

Dimensions

	Length		Width		Height		Inlet connection size	Outlet connection size
	mm	in	mm	in	mm	in	ANSI/DIN	ANSI/DIN
CXS160	1767	69.57	338	13.31	395	15.55	3"/DN80	2"/DN50
CXS 250	1767	69.57	338	13.31	395	15.55	3"/DN80	2"/DN50
CXS 160/EH500	1806.4	71.12	760	29.92	1373.4	54.07	ISO100	2"/DN50
CXS 160/EH1200	1806.4	71.12	760	29.92	1373.4	54.07	ISO160	2"/DN50
CXS 250/EH1200	1806.4	71.12	760	29.92	1373.4	54.07	ISO160	2"/DN50
CXS 250/EH2600	1806.4	71.12	760	29.92	1373.4	54.07	ISO160	2"/DN50

CDX1000 DRY PUMP



The CDX1000 is a dry vacuum pump with a double-ended screw mechanism designed for the chemical process, pharmaceutical and petrochemical industries. This innovative technology leverages Edwards' latest manufacturing and design philosophies.

With a pumping capacity of 530 cfm (900 m³h⁻¹), the CDX1000 is optimised for higher throughput processes where repeatability and reliability are key. Technologies and manufacturing techniques have been carefully selected to produce a high performance machine that is simple to operate and maintain.

PRODUCT FEATURES

PEACE OF MIND IN DEMANDING PROCESSES

Tolerant to process malfunctions

HIGH UPTIME

High reliability and on-site maintenance options

INDUSTRY PROVEN, TRIED AND TESTED

Specifically designed for larger, high-throughput chemical processes

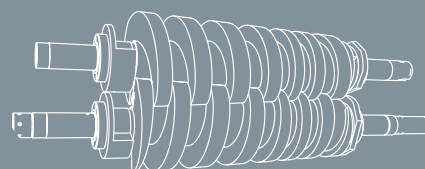

Technical Specifications

	Max Pumping Speed		Ultimate vacuum		Noise level dB(A)	Power consumption at 10 mbar (7.5 Torr)				Standard motor	
	m ³ /hr	cfm	mbar	Torr		kW		Hp		kW	Hp
CDX 1000	900	530	0.005	0.004	82	17.1		23.2		30	40
						Input power at ultimate		Max total inlet power			
						kW	Hp	kW	Hp		
CDX/EH2600	2735	1610	1.3x10 ⁻³	1x10 ⁻³	<85	22	30	35	47	11	15
CDX/EH4200	4184	2463	1.3x10 ⁻³	1x10 ⁻³	<85	22	30	35	47		
CDX/HV8000	6507	3830	1.3x10 ⁻³	1x10 ⁻³	<85	25	45	49	66		

Dimensions

	Length		Width		Height		Inlet connection size ANSI/DIN	Outlet connection size ANSI/DIN
	mm	in	mm	in	mm	in		
CDX 1000	2391	94.13	749	29.49	1011	39.8	6"/DN150	3"/DN80
CDX/EH2600	2500	98.43	1250	49.21	1850	72.83	ISO160	3"/DN80
CDX/EH4200	2500	98.43	1050	41.34	1800	70.87	ISO250	3"/DN80
CDX/HV8000	2500	98.43	1250	49.21	2050	80.71	10" Class A50 ASME B16.5	3"/DN80

LIQUID RING PUMPS

As a leader in vacuum technology, Edwards has developed a portfolio of products to meet the demanding applications in process industries.

The Edwards liquid ring pump range includes both one and two stage machines enabling optimum efficiency for processes operating across the vacuum range. Pump capacities up to 40,000 m³/h are available in one stage and 7,500 m³/h in two stage models.

HR Series

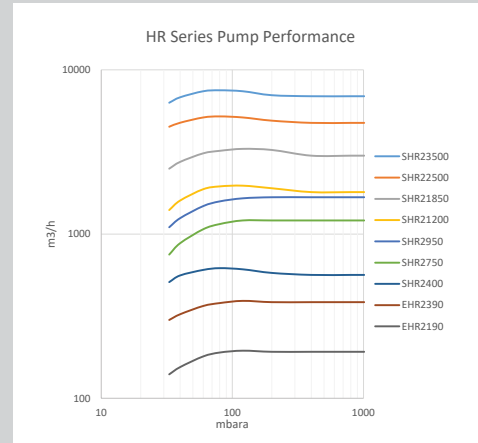

LR1A Series

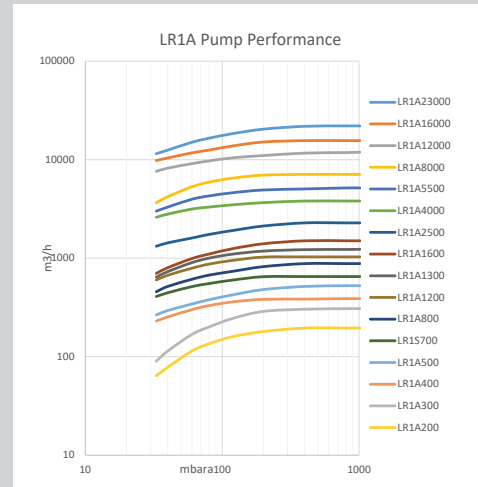

LR1B Series

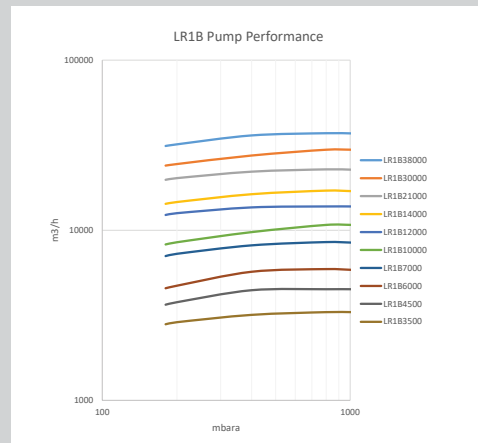

STANDARD LRP PACKAGES

Liquid ring vacuum pump performance is dependent upon the seal liquid properties; the seal liquid must be at a temperature which is low enough to enable the pump to operate at the desired suction pressure. To minimise the amount of seal water required it is often desirable to recycle the seal water back into the liquid ring pump, to enable this either some of the water must be replaced with fresh cooled water (partial re-circulation) or it should all be cooled by a heat exchanger (total re-circulation).

Edwards liquid ring vacuum pumps are offered as standard packages in three basic configurations, for operation in once through, partial or total re-circulation mode. Additionally, pumps are available in a selection of pump materials.

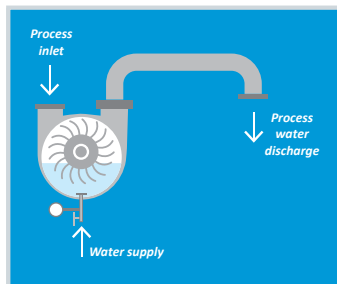

Once Through Operation

Used where an ample supply of service liquid which can be discharged to drain is available.

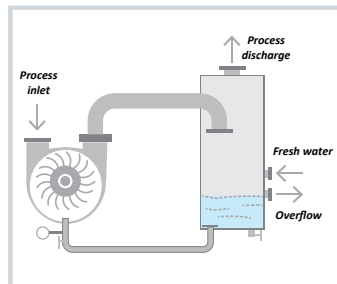

Partial Re-circulation

Operation The discharged seal liquid and gas stream is separated in the discharge separator, fresh liquid is added to reduce the temperature of the recycled mixture and the excess liquid goes to drain. This will reduce seal liquid usage by up to 50%.

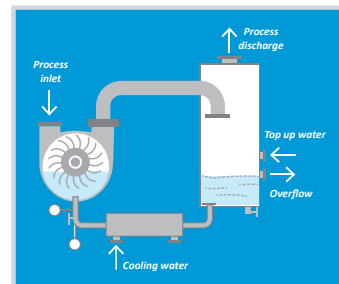

Total Re-circulation

Operation Used when seal liquid is in short supply or contamination of drains is an issue. To enable total re-circulation the separated liquid must be cooled before it is re-used. This is done by including a plate type heat exchanger in the return line.

ENGINEERED TO ORDER SYSTEMS

Complex packages are designed to meet the customer or process licence specifications, generally requiring project specific quality assurance program and extensive documentation packages. Edwards have many years experience in the design, engineering, assembly and testing of bespoke liquid ring pump and hybrid vacuum systems for the process markets, with equipment supplied for various process applications, including production of; aromatics, LAB, styrene, BPA, PTA, biofuels, fertilisers, adhesives and many others, providing customised solutions to meet customer requirements.

For more information on specific applications, please contact your local Edwards sales office.

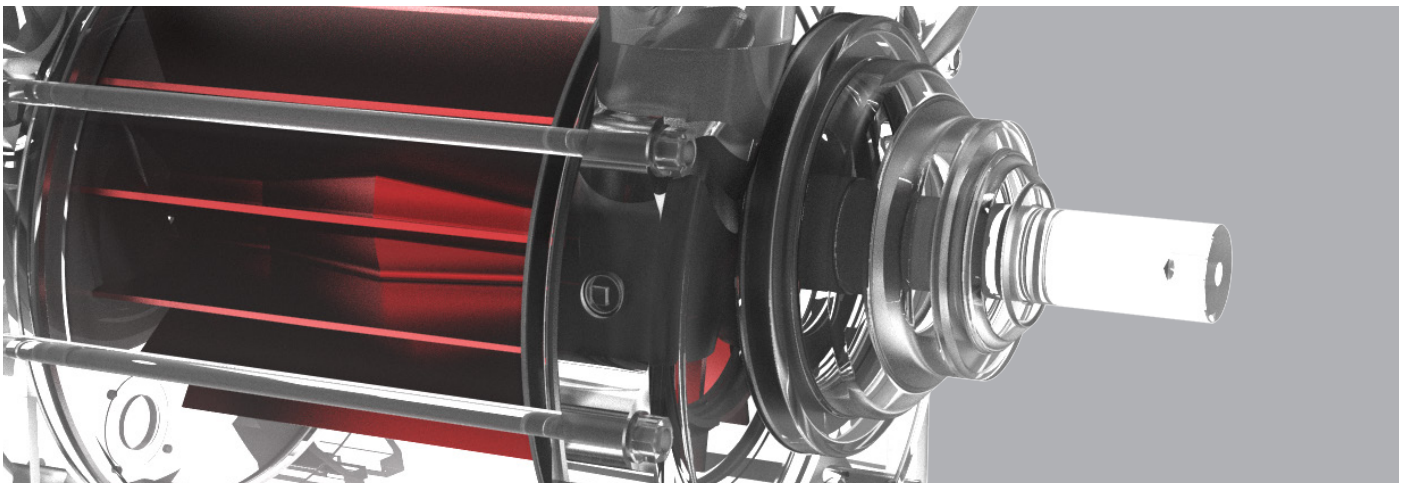



Mechanical Booster Options

Edwards pumps are available to be configured with a variety of vacuum booster pumps. Information on boosters can be found in this section - speak with Edwards about system configurations.

STOKES 6" MECHANICAL BOOSTER PUMP



Stokes 6" series mechanical boosters are designed to be used in conjunction with rotary piston, dry vacuum, rotary vane, liquid ring pumps or on the inlet of the backing pump to create a compact, integrated package. When coupled with one of these pumps, the Stokes 6" mechanical boosters increase pumping speed at working pressures and significantly reduce pumpdown time.

PRODUCT FEATURES

INDUSTRY STAPLE

Over 80 years of time-tested, proven performance with experienced service and technical support

EASY TO MAINTAIN

Single mechanical seal

INCREASED PRODUCTIVITY

Five seal design for optimal process protection

CONFIGURED FOR YOUR NEEDS

Bare shaft or direct drive, 1800-3600 rpm. Vertical or horizontal gas flow orientation with bypass versions available

Technical Specifications

	Displacement								Max pressure differential		Noise level	Motor power			
	1800 rpm		2750 rpm		3000 rpm		3600 rpm		mbar	Torr	dB(A)	50 Hz @ 3000 rpm		60 Hz @ 3600 rpm	
	m ³ /hr	cfm	m ³ /hr	cfm	m ³ /hr	cfm	m ³ /hr	cfm				kW	Hp	kW	Hp
607	1040	612	1589	935	1733	1020	2080	1224	506	380	65	7.5	10	3.7	15
607 PIB (process isolation)	n/a	n/a	1589	935	1733	1020	2080	1224	506	380	70	7.5	10	7.5	10
615	2210	1300	3375	2000	3685	2170	4420	2600	506	380	75	7.5	10	7.5@1800rpm 11@3600rpm	10@1800rpm 15@3600rpm
615 PIB (process isolation)	n/a	n/a	3375	2000	3685	2170	4420	2600	506	380	75	11	15	11	15
615 BP (Bypass)	2210	2000	3375	2000	3685	2170	4420	2600	n/a	n/a	<85	18	25	7.5@1800rpm 18@3600rpm	10@1800rpm 25@3600rpm
615 BP PIB (Bypass) Process isolation	n/a	n/a	3375	2000	3685	2170	4420	2600	n/a	n/a	<85	18	25	18	25
622	n/a	n/a	5100	3000	5525	2350	6630	3900	333	250	<82	18	25	18	25
622 (Process isolation)	n/a	n/a	5100	3000	5525	2350	6630	3900	333	250	<82	18	25	18	25

Dimensions

	Length		Width		Height		Inlet connection size	Outlet connection size
	mm	in	mm	in	mm	in		
607	1087	42.8	502	19.76	543	21.38	6" ASA/ANSI	6" ASA/ANSI
615	1369	53.9	502	19.76	543	21.38	8" ASA/ANSI	8" ASA/ANSI
622	1613	63.5	501	19.72	543	21.38	8" ASA/ANSI	8" ASA/ANSI

EH BOOSTERS



Edwards EH mechanical booster pumps feature a unique hydrokinetic drive which provides efficient power transmission with benefits in economy, performance and compactness. These booster pumps are suitable for use with high differential pressures, allowing the booster pump to be started at the same time as the backing pump, reducing total pumpdown times.

PRODUCT FEATURES

INCREASED PRODUCTIVITY
Faster pumpdown time

SIMPLE INSTALLATION
No need for pressure switches, bypass lines or variable frequency drives

RELIABLE OPERATION EVEN FOR HARSH DUTIES
Proven shaft seal design

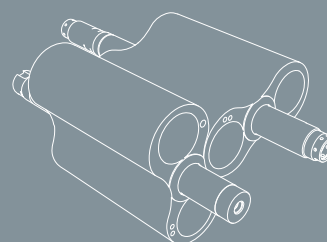

Technical Specifications

	Maximum Pumping Speed				Pressure differential across pump				Motor power			
	50 Hz		60 Hz		50 Hz		60 Hz		50 Hz		60 Hz	
	m ³ /hr	cfm	m ³ /hr	cfm	mbar	Torr	mbar	Torr	kW	Hp	kW	Hp
EH250	310	185	375	220	0-180	0-140	0-150	0-115	2.2	3	2.2	3
EH500	505	300	605	335	0-110	0-83	0-90	0-68	2.2	3	2.2	3
EH1200	1195	715	1435	845	0-90	0-68	0-75	0-56	3	4	3	4
EH2600	2590	1525	3110	1830	0-120	0-90	0-67	0-50	11	15	11	15
EH4200	4140	2440	4985	2935	0-70	0-52	0-50	0-38	11	15	11	15

Dimensions

	Length		Width		Height		Inlet connection size	Outlet connection size
	mm	in	mm	in	mm	in		
EH250	705	27.8	305	12	272	10.7	ISO63	ISO40
EH500	791	31.1	305	12	265	10.4	ISO100	ISO63
EH1200	953	37.5	380	15	334	13.1	ISO160	ISO100
EH2600	1156	45.5	522	20.6	479	18.9	ISO160	ISO100
EH4200	1336	52.6	522	20.6	479	18.9	ISO250	ISO100

GMB40K BOOSTERS



The new Edwards GMB40K has an innovative modular rotor design of high strength alloy-steel shafts with lightweight rotor lobes which safely enable higher running speeds. This patented construction gives maximum displacement on an industry leading footprint.

Edwards' innovative modular rotor technology ensures high performance on the smallest footprint and weight. This ensures the highest degree of flexibility when designing large vacuum systems.

PRODUCT FEATURES

FLEXIBLE
Multiple systemisation options

ECONOMICAL
Low cost of ownership

RELIABLE
Peace of mind for your process

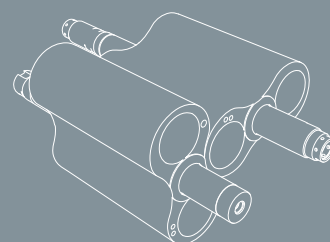

Technical Specifications

	Maximum pumping speed		Max pressure across booster		Noise level	Motor power		Total input power at ultimate	
	m ³ /hr	cfm	mbar	Torr		kW	Hp	kW	Hp
GMB40K	31,000*	18,250	25	18.75	80	IEC-30	NEMA-40	<2.5	<3.35

*with typical Edwards GXS or IDX based backing pumps @6,700m³/hr

Dimensions

	Length		Width		Height		Inlet connection size	Outlet connection size
	mm	in	mm	in	mm	in		
GMB40K	2344.2	92.3	851	33.5	985.5	38.8	DN500	ISO250

HV BOOSTER

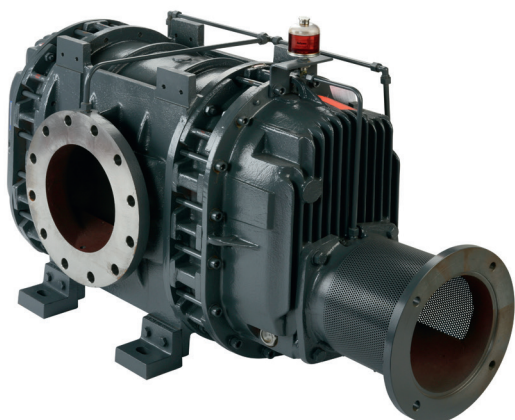

The HV mechanical booster pumps combine Edwards' expertise in manufacturing and distribution of complete vacuum systems with Dresser's world-renowned Roots pump technology.

When backed by a Drystar or EH mechanical booster, HV pumps provide totally oil-free, high-capacity pumping and operate reliably for long periods without maintenance.

PRODUCT FEATURES

STABLE PROCESS FOR CONSISTENT OUTPUT

Suitable for continuous operation over wide pressure ranges on heavy duty large scale applications

NO UNPLANNED DOWNTIME

High performance water-cooled mechanical shaft seal, large diameter shaft and large helical gears

EASY INTEGRATION AND SAFE TO OPERATE

Optional water-cooled exhaust gas after cooler, shaft seal safety purge, temperature monitoring and Variable Frequency Drive available

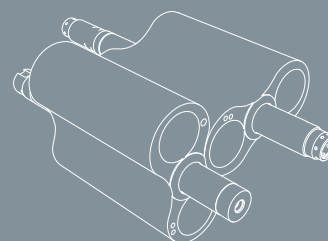

Technical Specifications

	Displacement				Pressure differential across pump				Noise level dB(A)	Motor power			
	50 Hz		60 Hz		50 Hz		60 Hz			50 Hz		60 Hz	
	m ³ /hr	cfm	m ³ /hr	cfm	mbar	Torr	mbar	Torr		kW	Hp	kW	Hp
HV8000	7200	4241	8640	5089	190	143	120	90	82	15	20	18.5	25
Horizontal gas flow variant available													
Vertical gas flow variant available													

Dimensions

	Length		Width		Height		Inlet connection size	Outlet connection size
	mm	in	mm	in	mm	in		
HV8000	1737	68.4	530	20.87	820	32.28	10" Class A50 ASME B16.5	10" Class A50 ASME B16.5
Horizontal	1737	68.4	530	20.87	820	32.28	--	--
Vertical	1737	68.4	670	26.38	638	25.12	--	--

pXH MECHANICAL BOOSTER PUMP



The pXH pumps represent the new generation of large mechanical boosters, providing high pumping capacity with reduced footprint. Available in sizes from 4102 to 4923 cfm (6965 to 8358 m³/h) displacement, pXH boosters are packaged as separate pumps with inverter-driven controls.

pXH can be easily integrated with GXS dry vacuum pumps, into a high pumping speed dry pump system.

PRODUCT FEATURES

RESILIENT

Designed to withstand harsh industrial applications

INTELLIGENT OPERATION

Inverter-driven control for 'plug and pump', flexible operation and automated control of your process

HIGH UPTIME

Consistent output and low maintenance

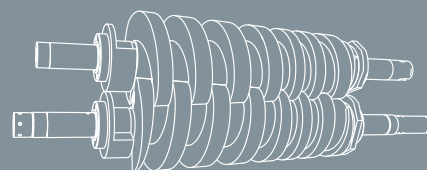

Technical Specifications

	Displacement		Motor rating		Noise level	Power at ultimate pressure	
	m ³ /hr	cfm	kW	Hp	dB(A)	kW	Hp
pXH4500	6965	4102	7.5	10	66	1.9	2.5
pXH6000	8358	4923	7.5	10	66	1.9	2.5

Dimensions

	Length		Width		Height		Inlet connection size	Outlet connection size
	mm	in	mm	in	mm	in		
pXH4500	1086	42.76	517	20.35	531	20.91	ISO200	ISO160
pXH6000	1086	42.76	517	20.35	531	20.91	ISO250	NW160

VAPOR BOOSTER PUMP



If you need higher pumping speeds up to 26,505 cfm (45000 m³h⁻¹) at pressures intermediate between mechanical boosters and diffusion pumps, our Vapor Booster Pumps are the ideal solution.

Field-proven for more than 60 years in various industries, they provide benefits such as ease of use, inherent reliability, ease of maintenance and tolerance to a wide range of inlet and exhaust pressures. They are perfectly at home in the metallurgy and coating industries as well as many other applications.

PRODUCT FEATURES

CONVENIENCE

Simple to operate

PERFORMANCE

Very high pumping speed and throughput at high operating pressures

RUGGED

Tolerant to high levels of dirt and dust - suitable for harsh environments

Technical Specifications

	AVS pumping speed		Maximum throughput		Heater Power	
	Air (l/s)	Hydrogen (l/s)	mbar (l/s)	Torr (l/s)	kW	Hp
18B4B	4000	6000	100	75	6	8
30B5M	12500	15000	300	225	22.5	30

Dimensions

	CL inlet flange to CL exhaust flange				Height		Inlet connection size	Outlet connection size
	mm		in		mm	in	ISO	NW
18B4B	1219		48		1880	74	8x11 mm holes on 387.4 PCD (Edwards) ANSI 12" ISO 160"	2" union (Edwards) ANSI 4" ISO160
	Length		Width					
	mm	in	mm	in				
30B5M	2569	101.1	966	38	3267	128.6	12x20.60mm holes on 686 PCD	4x16.7mm holes on 235 PCD

nHT HIGH THROUGHPUT DIFFUSION PUMPS



Edwards' nHT series diffusion pumps provide stable high throughput vacuum performance. Designed for optimum energy efficiency, flexibility and low maintenance, the nHT series is the ideal solution for a variety of demanding industrial applications.

nHT Series diffusion pumps have been designed for optimum heat transfer into the oil, resulting in faster heat up times and a significant reduction in energy consumption. In addition, use of the Energy Efficiency Controller (EEC) provides further reduction in power consumption - up to 30% without loss of pumping performance.

PRODUCT FEATURES

PERFORMANCE AND STABILITY

Optimised pumping speed and high throughput with good stability

FLEXIBILITY

Available in both ANSI and ISO flange options with voltage variants to cover global requirements

RELIABILITY

Smart temperature control and on-board sensors as standard ensure minimum load with longer lifetime for heaters and oil

CONTROL

The Energy Efficiency Controller enables ease of use and operating convenience along with effective monitoring with USB and Ethernet interface

Technical Specifications

	Pumping speed 10^{-4} mbar			Gas Throughput		Heater Power	
	Nitrogen (l/s)	Argon (l/s)	Helium (l/s)	mbar (l/s)	Torr (l/s)	kW	Hp
nHT10	3000	2750	4500	8	6	3.6	4.8
nHT16	6800	6350	9500	11	8.3	7.2	9.7
nHT20	10000	9000	17000	18	13.5	10.8	14.5
nHT35	30000	26000	42000	33	24.8	21.6	28.9

Dimensions

	Height		Inlet connection size	Backing connection size
	mm	in	ISO	NW
nHT10	788	31.0236	320 ISO-K	63 ISO-K
nHT16	1092	42.99	500 ISO-K	100 ISO-K
nHT20	1292	50.87	630 ISO-K	160 ISO-K
nHT35	1832	72.13	1000 ISO-K	200 ISO-K

MAXX DRY VACUUM SYSTEMS



MAXX systems represent a flexible and intelligent solution for a wide range of industrial applications where high pumping speed and fast pumpdown time are required.

MAXX dry vacuum systems are an integrated combination of our market leading GXS dry screw vacuum pumps and pXH boosters - the new generation of large mechanical boosters. The result is a flexible, modular skid design which is ideally suited for high capacity applications.

PRODUCT FEATURES

FLEXIBLE

Integrated modular skid design

INTELLIGENT

On-board controller with extensive and automated control capabilities

ECONOMICAL

Affordable capital investment and low cost of ownership

FAST

Reduced pumpdown times with ultimate vacuum $<5 \times 10^{-4}$ mbar

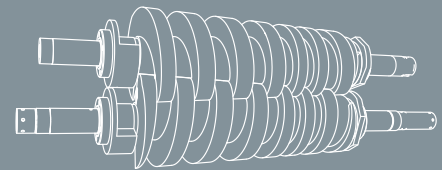

Technical Specifications

	Peak Pumping Speed		Ultimate pressure		Noise level	Full load power			
	m ³ /hr	cfm	mbar	Torr	dB(A)	Ultimate pressure		Peak pumping load	
						kW	Hp	kW	Hp
GXS450 & pXH4500 7.5kW	4250	2501	1.6x10 ⁻³	1.2x10 ⁻³	<64	7.9	10.6	16.8	22.5
2x GXS750 & pXH6000 7.5kW	6520	3838	1.6x10 ⁻³	1.2x10 ⁻³	<70	19.2	25.7	56.2	75.4
GXS750/2600 & pXH6000 7.5kW	6820	4914	2.8x10 ⁻⁴	2.1x10 ⁻⁴	<70	12	16.1	30.6	41
GXS750/4200 & pXH6000 7.5kW	7040	4143	2.7x10 ⁻⁴	2.0x10 ⁻⁴	<70	12.7	17	29.9	40.1
GXS750/2600 & 2x pXH6000 7.5kW	12500	7357	3.1x10 ⁻⁴	2.3x10 ⁻⁴	<70	14	18.8	31.3	42
GXS750/4200 & 2x pXH6000 7.5kW	13220	7781	2.9x10 ⁻⁴	2.2x10 ⁻⁴	<70	14.7	19.7	30.5	40.1

MAXX DRY VACUUM SYSTEMS

Dimensions

	Length		Width		Height		Inlet connection size	Outlet connection size
	mm	in	mm	in	mm	in		
GXS450 & pxH4500	1720	67.7	1150	45.3	2256	88.8	ISO200	NW50
2x GXS750 & pxH6000	1930	76	1740	68.5	2256	88.8	ISO250	NW50
GXS750/2600 & pxH6000	1750	68.9	1150	45.3	2256	88.8	ISO250	NW50
GXS750/4200 & pxH6000	1750	68.9	1150	45.3	2256	88.8	ISO250	NW50
GXS750/2600 & 2pxpXH6000	1900	74.8	2330	91.7	2256	88.8	ISO250	NW50
GXS750/4200 & 2pxpXH6000	1900	74.8	2330	91.7	2256	88.8	ISO250	NW50



APPLICATION ENGINEERING, DESIGN AND SYSTEMISATION



Our application expertise will ensure we can offer a comprehensive package of design and integrated system solutions.

Our highly focused applications team, central applications group and regional networks of application specialists are on hand to offer expert support throughout your selection and installation process.

Edwards application assistance includes capability to perform pumping simulations and modelling to help define the optimum vacuum solution for your requirement. Contact your Edwards representative for pumping system recommendations.

BOOSTER PUMPS & CONFIGURATIONS

Systems can be provided using standard configurators - ask an Edwards representative for details on combinations, accessories, etc.

Standard configurators include:

- EM/EH
- Stokes direct mount
- ES/booster
- IDX or 1700 package

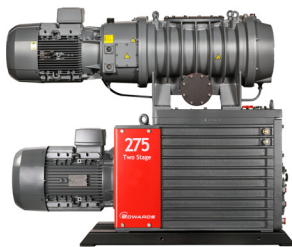

PROCESS DESIGN

EQUIPMENT SPECIFICATION AND SELECTION

SAFETY AND OPERATING PROCEDURES

VACUUM SYSTEMS AND CONTROL INTEGRATION

COMMISSIONING AND INSTALLATION

INSTALLATION AND OPERATIONAL QUALIFICATION FOR FDA COMPLIANCE



PUMP ACCESSORIES

Inlet dust filters

Available with pleated paper/polyester or metal mesh element to trap out particulates before they reach the pump. Suitable for trapping out particulates down to 5 microns

Inlet catchpots

Designed to minimise the entry of condensable vapors into the pump

Inlet chemical trap

Supplied with activated charcoal to provide protection against aggressive vapors and high molecular weight vapors. Activated alumina may also be used to create a large foreline trap to control any back-streaming at low inlet pressures

Outlet oil mist filters

Removes and collects oil mist from the exhaust line; ES pumps have integral oil mist filters

External oil filters

Remove particulate or acidic contaminants from the oil in the pump

Gas ballast valves

Auto control of gas ballast

Sensors and other

Temperature sensor, oil level monitors, water miser, vibration isolators

Measuring instruments

Range of instruments to measure vacuum over the range 2000 to 7×10^{-10} mbar

Edwards applies the same energy and commitment to its valves. The result is an extensive range of valves, with a choice of actuation methods, materials and size. Edwards vacuum fittings are designed to be leak-tight in vacuum applications.

SERVICE SOLUTIONS

We understand the importance of local support. Edwards has a number of major service facilities located in EMEA and throughout the rest of the world, each location supported by an extensive team of engineers and technicians to provide local, rapid response and great value service.

All of our service operations are conducted at the highest international standards in accordance with ISO9001 (Quality), ISO14001 (Environmental), and OHSAS18001 (Workplace safety).



COMPREHENSIVE SERVICE CAPABILITIES

EXTENDED WARRANTIES

REPAIR

MANAGED MAINTENANCE

CERTIFIED PRODUCTS



Vacuum Pumps for R&D Applications

At Edwards we have a deep understanding of research processes and the role that vacuum plays at every stage. This experience, coupled with innovative technologies and collaborative engineering, enables us to offer a comprehensive range of vacuum solutions that enhance performance across a broad range of scientific applications.

From the smallest school laboratory, to international R&D projects, our products and application know-how are facilitating educational development and scientific evolution across the globe.

VACUUM TECHNOLOGY FOR R&D APPLICATIONS

Our range of both dry and oil sealed primary pumps have become the industry standard due to their high reliability, performance capabilities and serviceability. For applications requiring high vacuum our comprehensive range of hybrid bearing and maglev turbomolecular pumps will provide pumping speeds from 47 to 4300 ls^{-1} . In applications involving UHV and XHV we offer a range of capture ion pumps achieving pressures of 10^{-11} mbar or lower.

nXDS and XDS dry scroll pumps

Edwards dry scroll pumps offer proven dry, clean vacuum solutions for a wide range of applications. nXDS is our latest generation of scroll pump offering increased pumping speeds, combined with lower ultimate pressures, lower power consumption and lower noise levels than other pumps.



nEXT and STP turbomolecular pumps

Edwards turbomolecular pumps are built on decades of experience and are drawing from our tried and trusted EXT and STP ranges. Our hybrid bearing nEXT pumps offer superior performance, reliability and end user serviceability, setting the benchmark for scientific turbomolecular pumps. As fully magnetically levitated pumps we offer our STP pump range.



RV two stage rotary vane pumps

Our RV series rotary vane pumps are rugged pumps that offer you an excellent ultimate vacuum with good pumping speeds, as well as superior vapor handling capabilities and quiet operation.



E2M

Ideal for dealing with extreme gaseous environments such as pharmaceutical freeze drying or refrigeration system evacuation, the EM series is the industry standard for zero contamination of process and effective lubrication under high gas loads.



NOTES

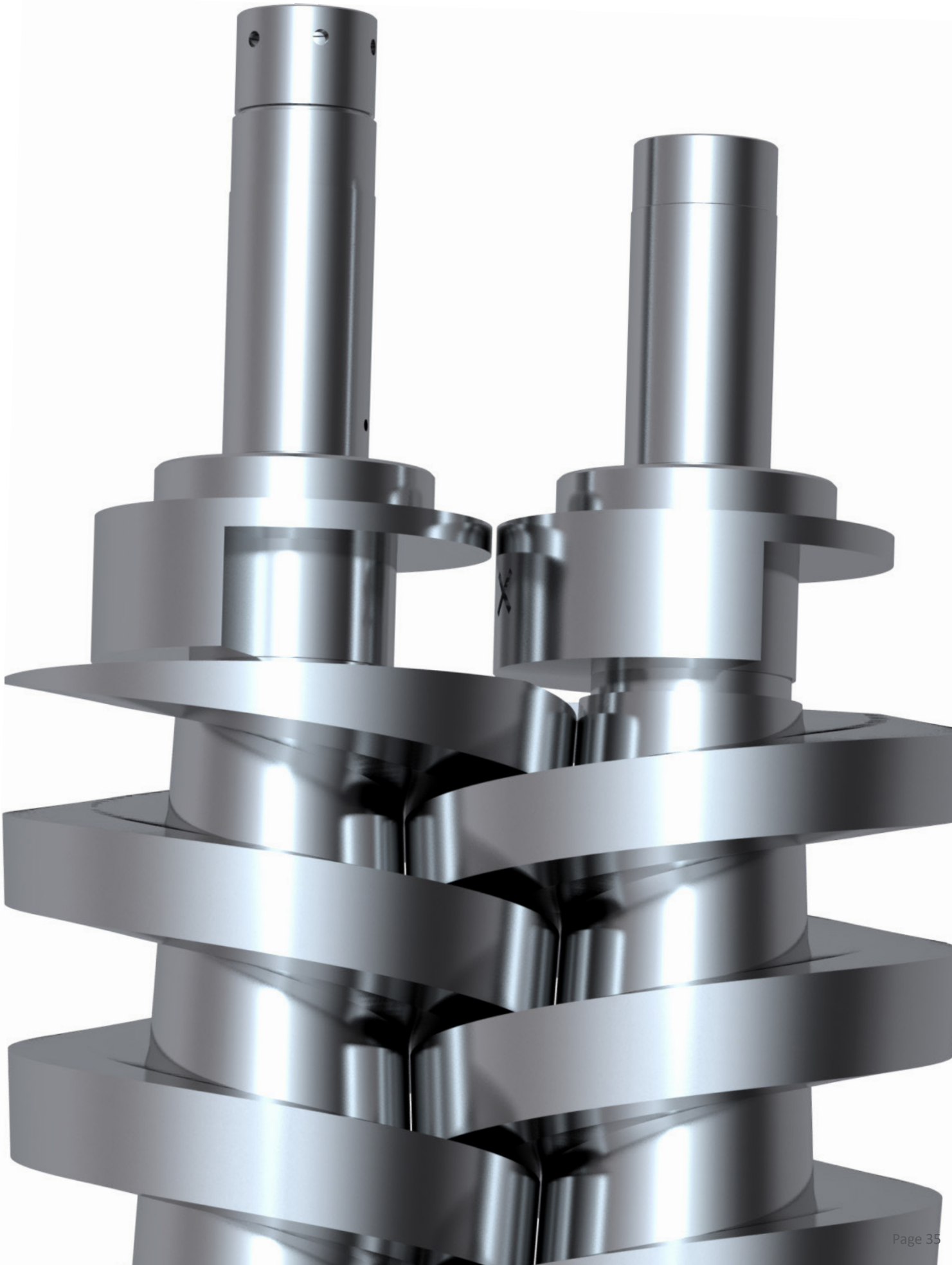



LOCAL & GLOBAL CONTACTS

Poland		Israel	+ 972 8 681 0633
Artur Ginalski	+48 734 474 189	Middle East & Africa	+420 533 441 045
	artur.ginalski@edwardsvacuum.com	ASIA PACIFIC	
Eastern Europe		China	+86 400 111 9618
	+420 (0) 533 441 045	India	+91 20 4075 2222
	ExportSales@edwardsvacuum.com	Japan	+81 47 458 8836
Rest of EMEA		Korea	+82 31 716 7070
UK	+44 1444 253 000	Singapore	+65 6546 8408
	08459 21 2223	Taiwan	+886 3758 1000
BeNeLux	+44 1293 60 3350	AMERICAS	
France	+33 1 4121 1256	USA	+1 800 848 9800
Germany	0800 000 1456	Brazil	+55 11 3952 5000
Italy	+ 39 02 48 4471		

Publication Number: 3602 505 9 01
 © Edwards Limited 2020. All rights reserved
 Edwards and the Edwards logo are trademarks of
 Edwards Limited

Whilst we make every effort to ensure that we
 accurately describe our products and services,
 we give no guarantee as to the accuracy or
 completeness of any information provided in
 this brochure.

Edwards Ltd, registered in England and Wales
 No. 6124750, registered office: Innovation Drive,
 Burgess Hill, West Sussex, RH15 9TW, UK.